

INSTALLATION INSTRUCTIONS

61147 (1 - 3 - 4) SIDE BAR

09 - 13 DODGE RAM 1500 CREW CAB. 6' 5" BED P/U 2/4 WD

Parts List:

ITEM	QTY.	CODE	DESCRIPTION	TORQUE MAX.
1	1	373198AA-8CA	Side Bar front set	-
2	1	373198AA-8CA	Side Bar rear set	-
	1	BRK-37719	Brackets kit includes:	
3	1	372244BB	Front mounting brackets set	-
4	1	376194AA	Rear mounting brackets set	-
5	2	372242AB	Front auxiliary mounting bracket	-
6	2	372242BA	Rear auxiliary mounting brackets	-
7	4	372240BA	"T" Plate	30 Lb.Ft
	1	KTE-37719	Hardware kit includes:	
8	2	-	1/2 x 4" Hex head bolt zinc plated	75 Lb.Ft
9	2	-	1/2" Flat washer zinc plated	75 Lb.Ft
10	6	-	1/2" Lock washer zinc plated	-
11	4	-	1/2" hex nut zinc plated	-
12	2	-	1/2 x 2" hex head bolt zinc plated	75 Lb.Ft
13	16	-	3/8 x 1 1/4" hex head bolt zinc plated	30 Lb.Ft
14	22	-	3/8" lock washer zinc plated	-
15	20	-	3/8" flat washer zinc plated	-
16	8	-	3/8" hex nut zinc plated	30 Lb.Ft
17	4	-	Vinyl gaskets	-

Required Tools (not included)

DESCRIPTION	QTY
9/16" Socket / wrench	1
3/4" Socket / wrench	1
Ratchet	1
Ratchet extension	1
3/16" Wrench allen	1

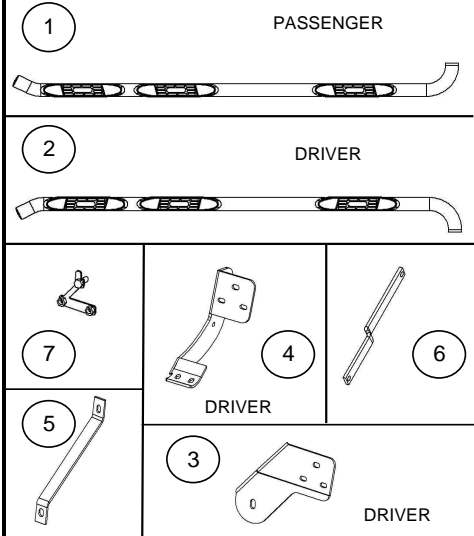
ILLUSTRATION 1

Approximate installation time: 40 min.
Instructions:

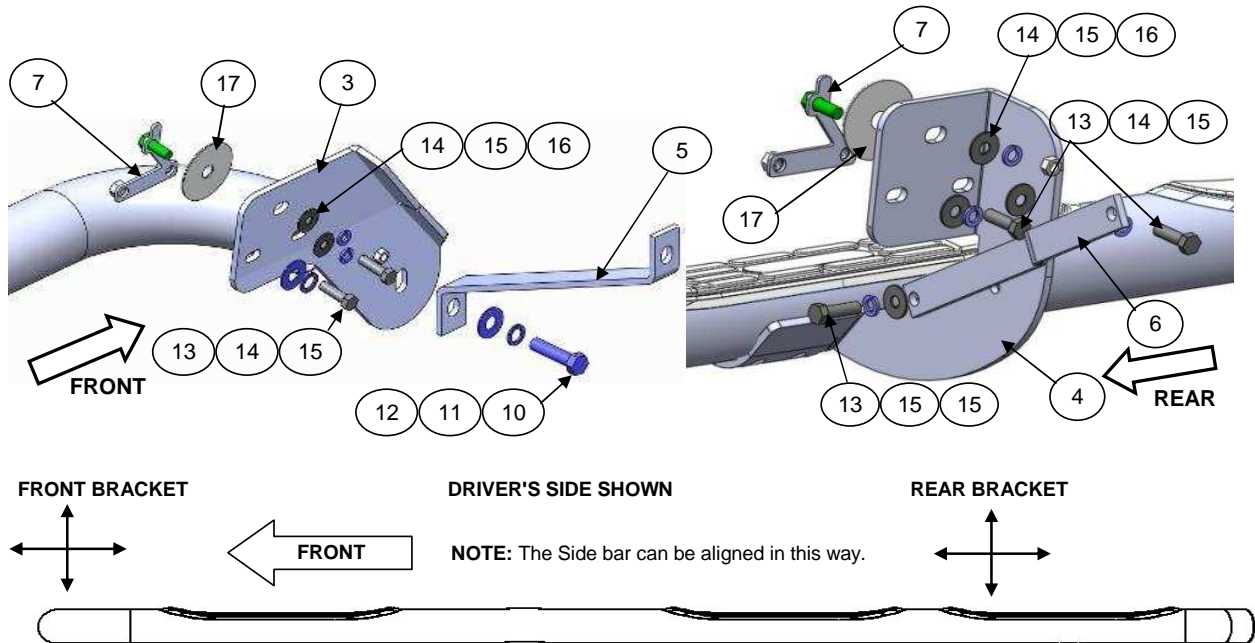
Before beginning the installation, please read all directions carefully and verify all necessary hardware is accounted for. If any parts are missing, stop the installation and contact your distributor immediately.



1. To install front & rear mounting brackets locate in the rocker panel the holes covered in tape and remove the tape. Place (1) vinyl gasket to the bolt of the "T" plate then insert into the exposed hole. **See picture 1.** **NOTE:** It is important to place vinyl gaskets to the bolts to prevent the "T" plate from falling into the rocker panel.

Cleaning and care instructions:

Design:

Quality:

Keep your product clean. Do not use abrasive cleaners or polish. We recommend only non-abrasive automotive wax such as pure carnauba to avoid scratches or rust.

INSTALLATION INSTRUCTIONS

37319 (1 - 3 - 4) SIDE BAR

2. Place (1) front mounting bracket attach to the bolt of "T" plate previously placed using: (1) 3/8" flat and lock washers and 3/8" hex nut. Secure to the nuts of "T" plate using (2) 3/8 x 1 1/4" hex head bolt, (2) 3/8" flat and lock washers. **See Picture 2.** Leave loose. Repeat the procedure to install rear mounting bracket.

3. To install auxiliary front mounting bracket, locate existing hole in the chassis then place (1) 1/2 x 4" hex head bolt with (1) 1/2" flat washer. Place auxiliary front mounting bracket and secure using (1) 1/2" flat and lock washers and (1) 1/2" hex nut. **See picture 2.** Leave loose.

PICTURE 1

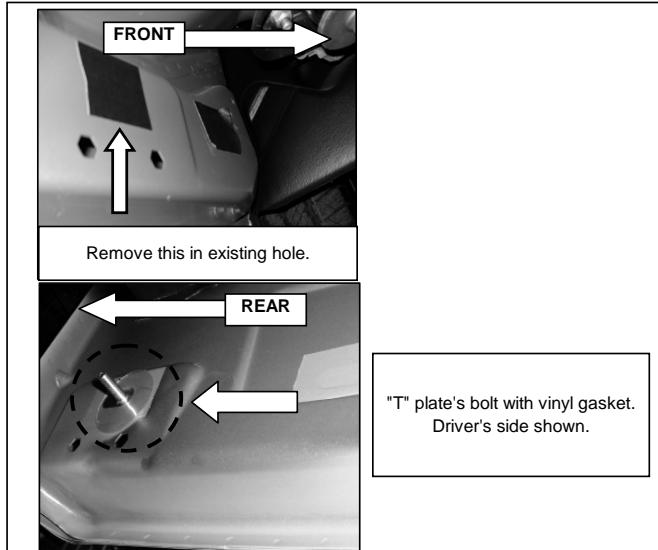

PICTURE 2

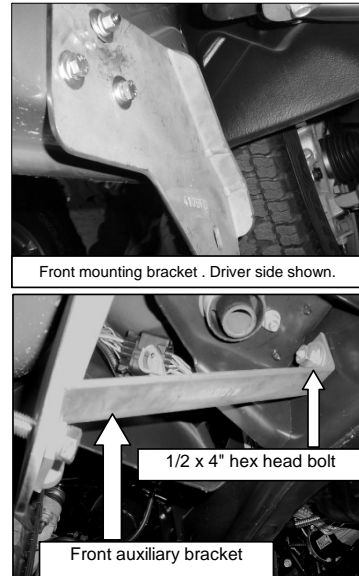

4. To install auxiliary rear mounting bracket, locate existing hole in the chassis support. **See Picture 3.** Introduce (1) 3/8 x 1 1/4" hex head bolt then place rear auxiliary mounting bracket and secure to the bolt previously placed using (1) 3/8" flat and lock washers and 3/8" hex nut. Secure the other end to the rear mounting bracket using (1) 3/8 x 1 1/4" hex head bolt, (1) 3/8" flat and lock washers and (1) 3/8" hex nut. Leave loose. **Picture 4.**

5. Place Side Bar to the front mounting brackets and secure using (1) 1/2 x 2" hex head bolt, and (1) 1/2" flat and lock washers. Secure to the rear mounting brackets using (2) 3/8 x 1 1/4" hex head bolt, and (2) 3/8" flat and lock washers. **NOTE:** Using same 1/2" bolt secure front mounting bracket and auxiliary front mounting bracket to Wheel to Wheel . Leave loose.

PICTURE 3

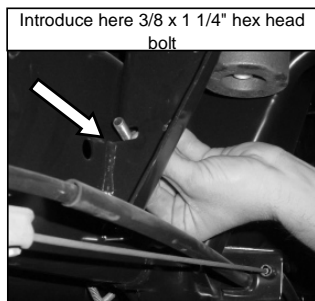

PICTURE 4

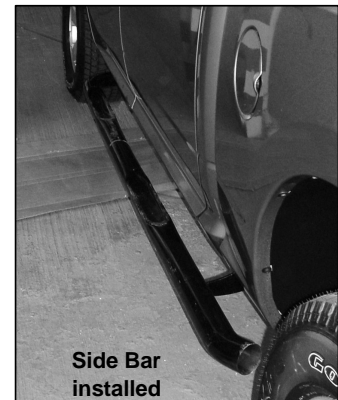
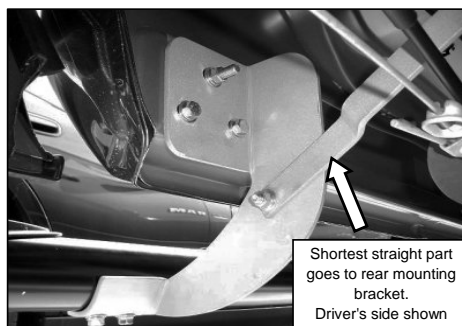

6. Align the Side Bar to the vehicle and tighten all hardware. Finally place a plastic plug into the hole of the tube's joint.

7. Repeat for the other side of vehicle.

8. Fill out the warranty card included and place it inside your vehicle.

Cleaning and care instructions: Design:

Quality:

Keep your product clean. Do not use abrasive cleaners or polish. We recommend only non-abrasive automotive wax such as pure carnauba to avoid scratches or rust.