

# INSTALLATION INSTRUCTIONS

BRACKET	OVAL SIDE BAR WIDESIDER 4"	WHEEL TO WHEEL WIDESIDER 4"	RUNNING BOARD WIDESIDER 5" & 6"	APPLICATION	MODEL
684126	64126 67126	-	680087	FORD F-150 SUPER CAB.	04 - 13
	64150 67150	-	680087	FORD F-150 SUPER CREW	04 - 08
	64151 67151	-	680087	FORD F-150 SUPER CREW	09 - 13

**Parts List:**

ITEM	QTY.	CODE	DESCRIPTION	TORQUE
1	3	391694BB	Brackets set ( Front & Middle & Rear )	-
2	2	371980EA	3/8" bolt plate	30 Lb/Ft
<b>KTE-391695 Hardware kit including:</b>				
3	12	-	5/16" Square head bolt	11 Lb/t
4	12	-	5/16" Flat washer	-
5	12	-	5/16" Lock washer	-
6	12	-	5/16" Hex nut	11 Lb/t
7	6	-	3/8" Clip nut	-
8	6	-	3/8 x 1 1/4" Hex head bolt	30 Lb/Ft
9	6	-	3/8 x 1 1/4" Carriage head bolt	30 Lb/Ft
10	12	-	3/8" Flat washer	-
11	12	-	3/8" Lock washer	-
12	8	-	3/8" Hex nut	30 Lb/Ft
13	2	-	Gasket vinyl	-
<b>NOTE: 64126-67126 (B-PS) / 64150-67150 (B-PS) / 64151-67151 (B-PS) INCLUDES:</b>				
14	1	-	Oval side bar widesider 4"	-

**Tools required not including:**

DESCRIPTION	QTY
9/16" & 1/2" Hex socket	1
17mm Double hex socket ( 12 point ) or 15mm Wrench	1
Ratchet	1
Ratchet extension	1

**ILLUSTRATION 1**

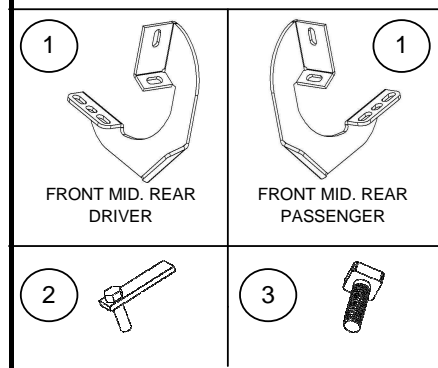

**Approximated installation time: 30 min.**

**Instructions:**

1. Before beginning the installation read all instructions thoroughly and verify that all hardware is accounted for. If there are any listed parts missing, please notify your distributor immediately.

**ILLUSTRATION 2.**

**Running board widesider 5" & 6" /  
Oval Side Bar widesider 4"  
NOT INCLUDED**

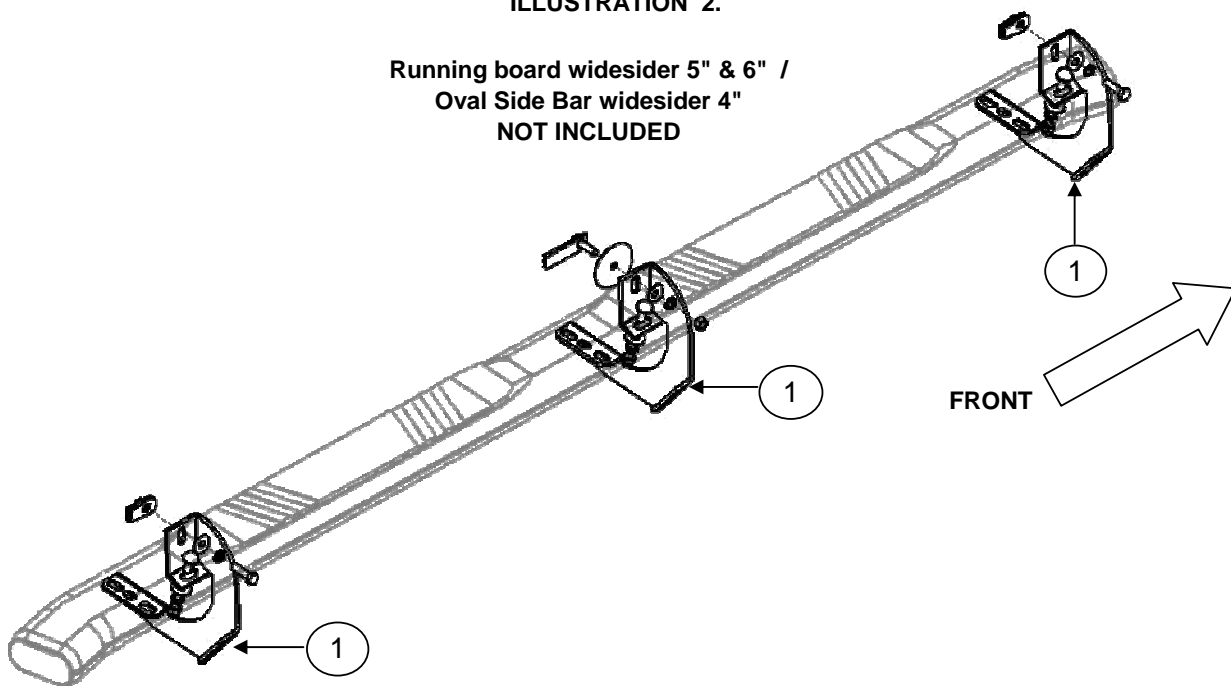

**Illustration driver side.**

**Cleaning and care instructions:**

Protect the finish with a non-abrasive automotive wax, (e.g. Pure Carnauba) on a regular basis. The use of any soap, polish, or wax that contains an abrasive is detrimental to the finish, as the compounds scratch the finish and cause corrosion.

Design:

Quality:

## INSTALLATION INSTRUCTIONS

2. Located holes inside the body of vehicle, front, middle, rear, place a clip nut in upper part. Mount bracket and attach with: 3/8 x 1 1/4" hex head bolt, 3/8" flat and lock washers. **NOTE 1: Models 2009 - 2012 insert 3/8" bolt plate, gasket vinyl, middle part, attach with: 1 3/8" flat and lock washers, 3/8" hex nut.** In lower part by each bracket attach with: 3/8 x 1" carriage head bolt, 3/8" flat and lock washers, 3/8" hex nut. **SEE ILLUSTRATION 3 & 4.** Leave loose. Repeat in opposite side.

**ILLUSTRATION 3**

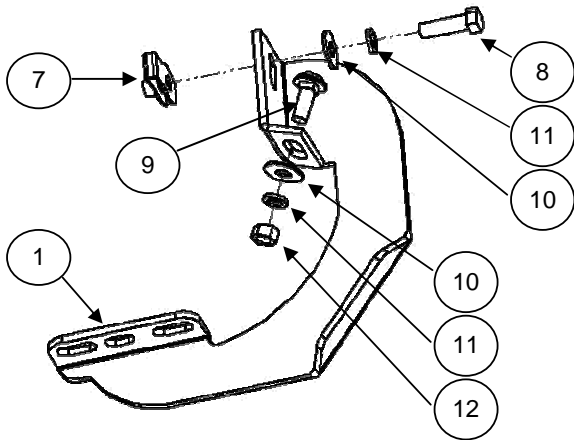

Use ratchet & 9/16" hex socket.

In models 09 - 12 front and rear part. Driver side.  
In models 04 - 08 front, middle and rear part. Driver side.

**ILLUSTRATION 4**

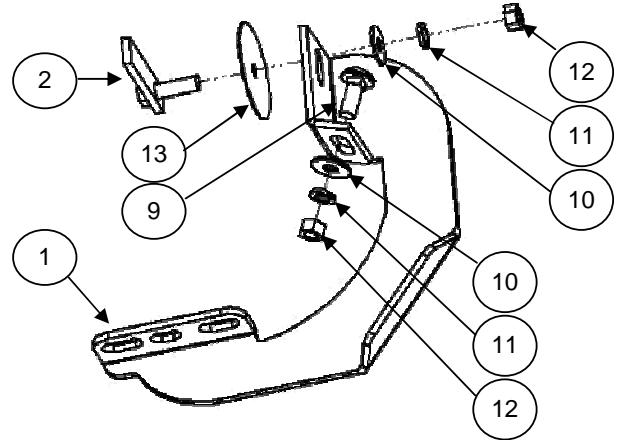

Use ratchet & 9/16" hex socket.

In models 09 - 12 middle part. Driver side.

3. If you acquired a Running board widesider 5" & 6", insert 5/16" square head bolt on rail, place on brackets and attach with: 5/16" Flat and lock washer, 5/16" hex nut. **SEE ILLUSTRATION 5.** Repeat for the opposite side. Leave loose.

4. If you acquired a Oval side bar widesider 4", place on brackets and attach with: 5/16" square head bolt, 5/16" Flat and lock washer. **SEE ILLUSTRATION 6.** Repeat for the opposite side. Leave loose.

5. Align Running board widesider 5" & 6" or Oval side bar widesider 4" and then tighten all bolts.

6. Do not use abrasive substances to clean your product.

7. Periodically check your product because it may need a re-tighten of bolts.

8. Fill the warranty card and place it inside your vehicle's glove box.

**ILLUSTRATION 5**

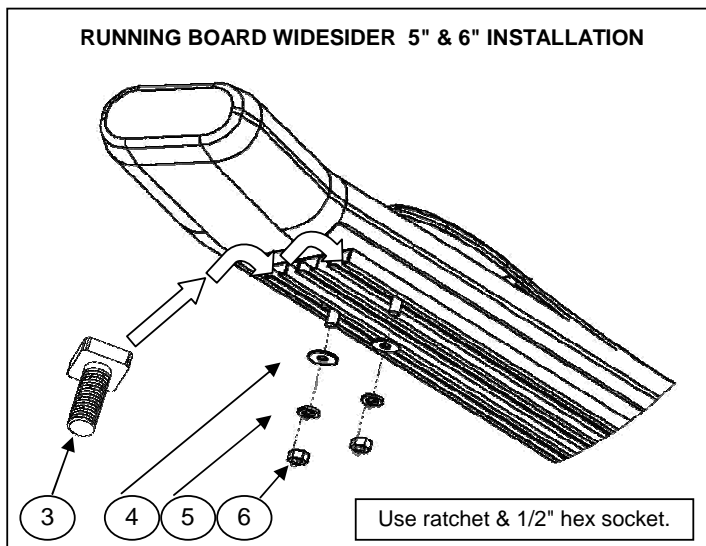

**ILLUSTRATION 6**

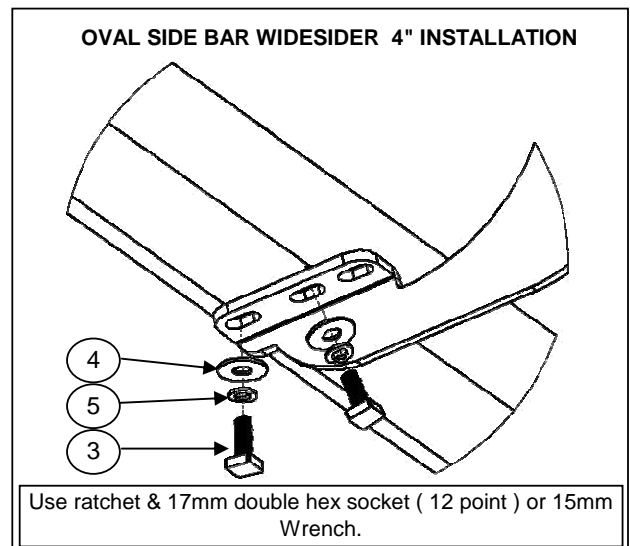

**Cleaning and care instructions:**

Protect the finish with a non-abrasive automotive wax, (e.g. Pure Carnauba) on a regular basis. The use of any soap, polish, or wax that contains an abrasive is detrimental to the finish, as the compounds scratch the finish and cause corrosion.

Design:

Quality: