

393245  
6843995

INSTALLATION INSTRUCTIONS

DODGE RAM 1500 CREW CAB AND QUAD CAB

2015  
2016

| Parts List |                   |                               |                                       |             |
|------------|-------------------|-------------------------------|---------------------------------------|-------------|
| Item       | Qty.              | Code                          | Description                           | Max. Torque |
| 1          | 1 Set             | 393240AA                      | Front bracket                         | -           |
| 2          | 2 Set             | 3912240AB                     | Middle and rear bracket               | -           |
| 3          | 2 Piece           | 391223EA                      | Auxiliary front bracket               | -           |
| 4          | 1 Set             | 393244AA                      | Auxiliary rear bracket                | -           |
| 5          | 6 Piece           | 372240BA                      | 3/8" Bolt plate                       | 30 Lb.Ft    |
| 6          | 2 Piece           | 378312                        | 1/2" Bolt plate                       | 75 Lb.Ft    |
| 7          | 2 Piece           | 3713312                       | 5/16" Bolt plate                      | 11 Lb.Ft    |
| <b>1</b>   | <b>KTE-393245</b> | <b>HARDWARE KIT INCLUDES:</b> |                                       | -           |
| 8          | 12 Piece          | -                             | 5/16" x 1" Hex head bolt black plate. | 11 Lb.Ft    |
| 9          | 12 Piece          | -                             | 5/16" Flat washer black plate.        | -           |
| 10         | 12 Piece          | -                             | 5/16" Lock washer black plate.        | -           |
| 11         | 12 Piece          | -                             | 5/16" Hex nut black plate.            | 11 Lb.Ft    |
| 12         | 8 Piece           | -                             | 5/16" Vinyl Gasket                    | -           |
| 13         | 16 Piece          | -                             | 3/8 x 1" Hex head bolt.               | 30 Lb.Ft    |
| 14         | 20 Piece          | -                             | 3/8" Flat washer.                     | -           |
| 15         | 20 Piece          | -                             | 3/8" Lock washer.                     | -           |
| 16         | 8 Piece           | -                             | 3/8" Hex nut.                         | 30 Lb.Ft    |
| 17         | 12 Piece          | -                             | M8 x 25mm Hex head bolt.              | 30 Lb.Ft    |
| 18         | 2 Piece           | -                             | 5/16" Hex nut.                        | 11 Lb.Ft    |
| 19         | 14 Piece          | -                             | 5/16" Flat washer.                    | -           |
| 20         | 14 Piece          | -                             | 5/16" Lock washer.                    | -           |
| 21         | 2 Piece           | -                             | 1/2" Flat washer.                     | -           |
| 22         | 2 Piece           | -                             | 1/2" Lock washer.                     | -           |
| 23         | 2 Piece           | -                             | 1/2" Hex nut.                         | 75 Lb.Ft    |

| Required Tools (Not included) |                                   |
|-------------------------------|-----------------------------------|
| Qty.                          | Description                       |
| 1                             | 1/2 - 9/16 - 3/4" Socket & Wrench |
| 1                             | 13mm Socket & Wrench              |
| 1                             | Ratchet                           |
| 1                             | Ratchet extension                 |

| Product Image |                                            |
|---------------|--------------------------------------------|
| 1             | <p>Driver Passenger</p>                    |
| 2             | <p>Middle Driver Side Rear Driver Side</p> |
| 3             |                                            |
| 4             | <p>Driver Passenger</p>                    |
| 5             |                                            |
| 6             |                                            |
| 7             |                                            |

Instructions

**Do not attempt to install this product on any vehicle other than the one it is designed for and listed above!**

1. Before beginning the installation, please read all directions carefully and verify that all necessary hardware is accounted for. If any parts are missing, stop the installation and contact your distributor immediately.
2. To maintain and care this product, keep it clean and do not use abrasive cleaners or polish waxes. We recommend to use only automotive wax such as pure carnauba to avoid scratches and rust.
3. The approximate installation time is 50 min.
4. This installation uses 3 brackets per side, **(Photo 1)**.

PHOTO 1



### Front Bracket.

5. Begin the installation on the driver side of the vehicle.

6. If the vehicle has (2) hexagon shaped holes in the rocker panel at the front of the cab, remove the tape covering the obround hole in the rocker panel, and install (1) 3/8" T-Plate in the rocker panel and install (1) vinyl gasket over the threads to prevent the T-Plate from falling into the body, **(Photo 2)**. Align the nuts welded to the T-Plate with the hexagon holes in the rocker panel and attach the driver side front bracket to the rocker panel using the (2) 3/8" X 1 1/4" hex bolts, (2) 3/8" flat washers and (2) 3/8" lock washers, **(Photo 3)**. Leave the bolts loose for final adjustment.

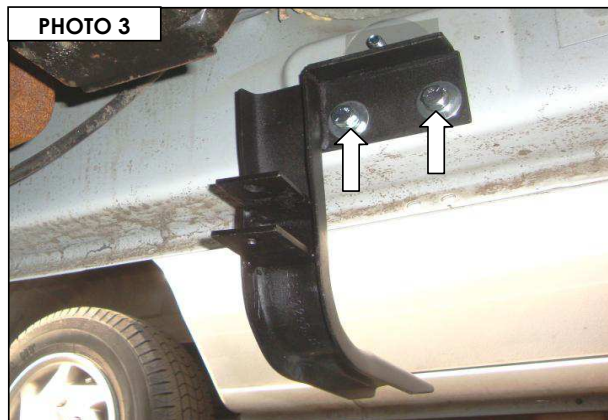
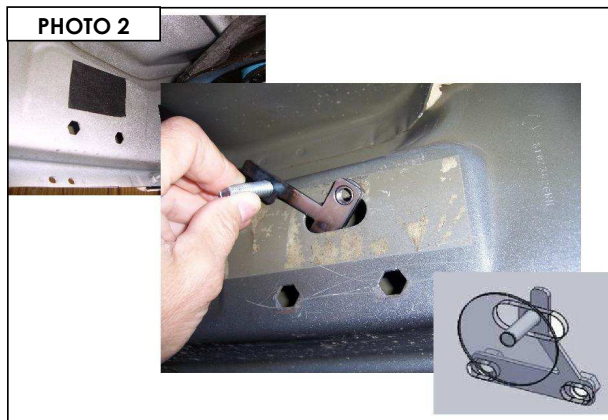

### Front Bracket

7. If the vehicle has (2) M8 threaded inserts in the rocker panel at the front of the cab, **(Photo 4)**. Attach the driver side front bracket to the rocker panel using (2) M8 hex bolts, (2) 5/16" lock washers and (2) 5/16" flat washers, **(Photo 5)**. Leave the bolts loose for final adjustment.

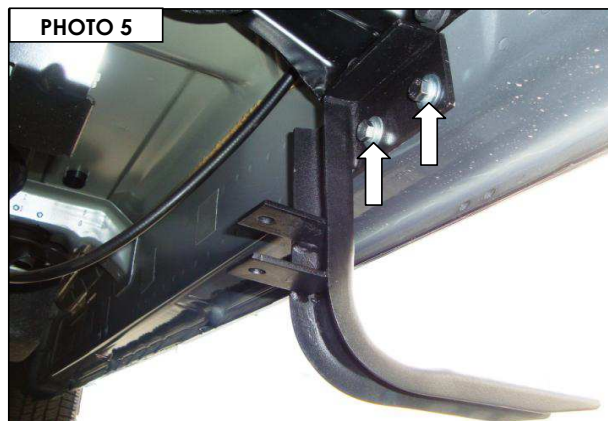
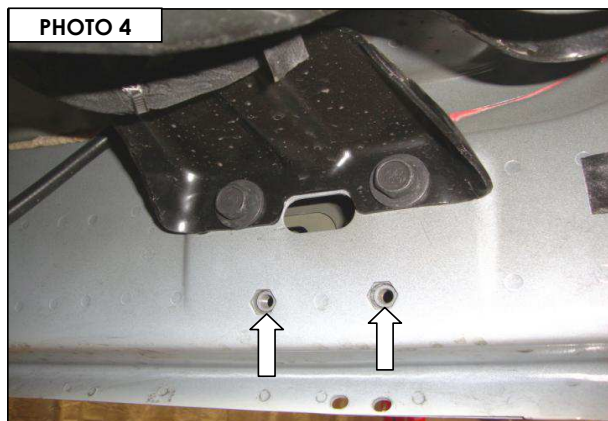

### Front Auxiliary Bracket

8. Locate the obround hole in the bottom of the frame rail **(Photo 6)** and install one 5/16" T-Bolt in the hole. Attach one of the front auxiliary brackets to the bottom of the frame using the T-Bolt (1) 5/16" flat washer, (1) 5/16" lock washer and (1) 5/16" hex nut. Attach the opposite end of the auxiliary bracket to the underside of the upper tab on the front bracket using (1) 3/8" x 1" hex bolt, (1) 3/8" flat washer, (1) 3/8" lock washer and (1) 3/8" hex nut, **(Photo 7)**. Leave the nuts and bolts loose for final adjustment.

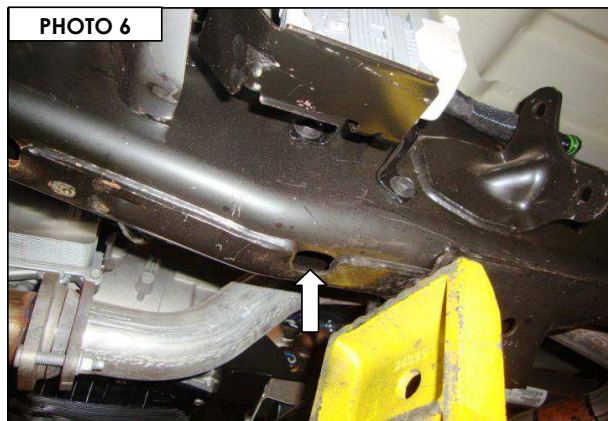



### Front Auxiliary Bracket (Eco Diesel)

9. Locate the obround hole in the bottom of the frame cross member (**Photo 8**) and install one 5/16" T-Bolt in the hole. Attach one of the front auxiliary brackets to the bottom of the cross member using the T-Bolt (1) 5/16" flat washer, (1) 5/16" lock washer and (1) 5/16" hex nut. Attach the opposite end of the auxiliary bracket to the underside of the lower tab on the front bracket using (1) 3/8" x 1" hex bolt, (1) 3/8" flat washer, (1) 3/8" lock washer and (1) 3/8" hex nut, (**Photo 9**). Leave the nuts and bolts loose for final adjustment.

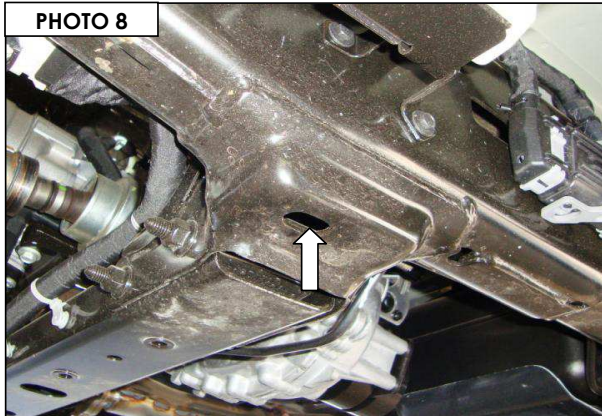

### Center & Rear Bracket

10. If the vehicle has hexagon holes in the rocker panel at the center and rear of the cab, remove the tape covering the obround hole in the rocker panel, and install (1) 3/8" T-Plate in the rocker panel and install (1) vinyl gasket over the threads to prevent the T-Plate from falling into the body, (**Photo 10**). Align the nuts welded to the T-Plate with the hexagon holes in the rocker panel and attach one of the (center/rear) brackets to the rocker panel using the T-Plate, (2) 3/8" X 1" hex bolts, (3) 3/8" flat washers, (3) 3/8" lock washers and (1) 3/8" hex nut, (**Photo 11**). Leave the nut and bolts loose for final adjustment.

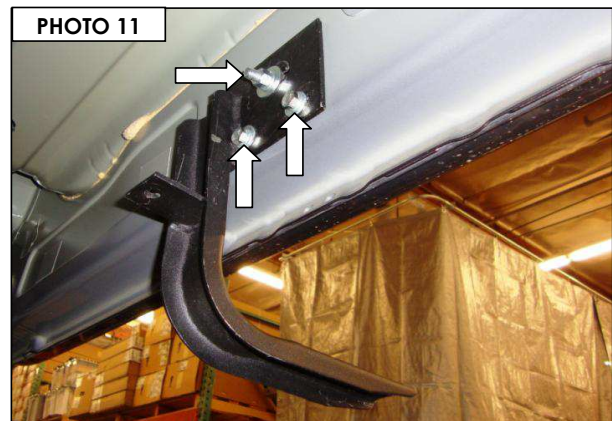
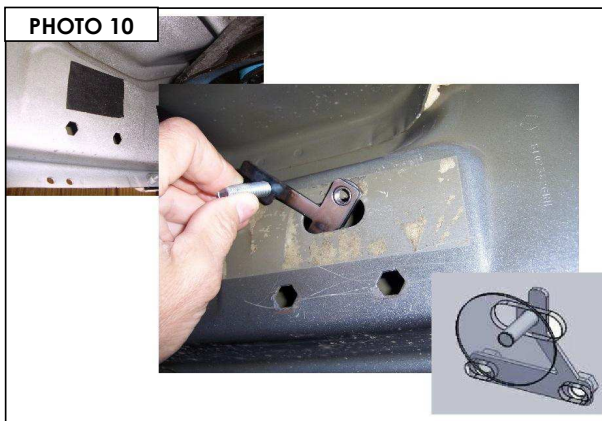

### Center & Rear Bracket

11. If the vehicle has M8 threaded inserts in the rocker panel at the center and rear of the cab; install (1) 3/8" T-Plate in the oblong hole in the rocker panel and install (1) vinyl gasket over the threads to prevent the T-Plate from falling into the body, (**Photo 12**). Rotate the T-Plate so the nuts welded to the T-Plate clear the M8 threaded inserts in the rocker panel then attach one of the (center/rear) brackets to the rocker panel using the T-Plate (1) 3/8" flat washer, (1) 3/8" lock washer, (1) 3/8" hex nut, and (2) M8 hex bolts, (2) 5/16" lock washers and (2) 5/16" flat washers, (**Photo 13**). Leave the nut and bolts loose for final adjustment.

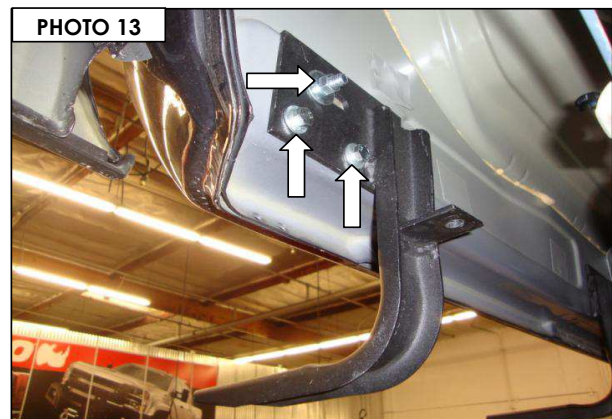





**15.** If installing 415 side steps place the side step on top of the brackets, align the threaded inserts in the side step with the holes in the brackets and secure the side step to each bracket using (2) 5/16" x 1" hex bolts, (2) 5/16" lock washers and (2) 5/16" flat washers. Align the side step with the vehicle then tighten all side step and bracket nuts and bolts.

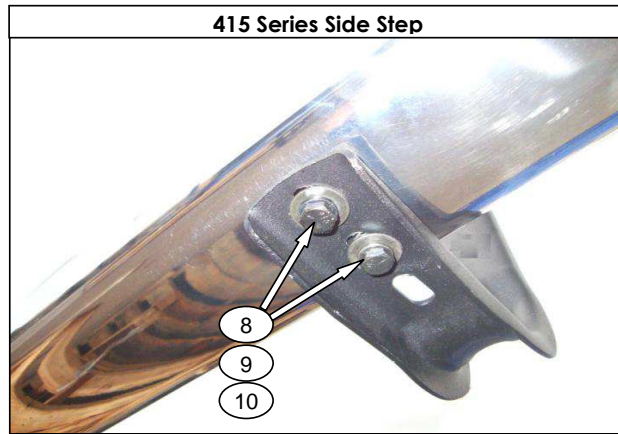

- 16.** Repeat the above installation steps to install the brackets and side step on the passenger side of the vehicle.  
**17.** Remember to check and repair the hardware periodically.