

# GO RHINO®

## INSTALLATION INSTRUCTIONS

### HD SIDE STEPS

Parts List			
Item	QTY	Code	Description
1a	1 set	660352T	HD Side Step
1b	1 set	660380T	HD Side Step
1c	1 set	660387T	HD Side Step
2	6 pcs	397872AA	U (clamp) Bracket

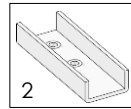
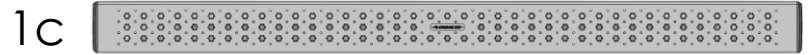
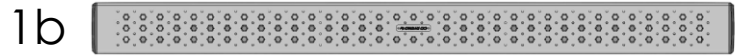
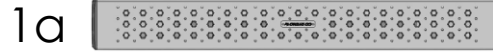

#### Required Tool:

- A. Ratchet & Extension
- B. ½" Wrench
- C. ½" Socket

1. Before beginning the installation read all instructions thoroughly and verify that all hardware is accounted for. If there are any listed parts missing, please notify your distributor immediately.
2. To maintain and care this product keep it clean and do not use abrasive cleaners or polish waxes. It is recommended to use only non-abrasive automotive wax such as pure carnauba to avoid scratches and rust.
3. Once the main brackets are installed (sold separately), the approximate installation time is 15 min.
4. Identify the outboard side of the HD Side Step prior to install. See illustration 1.
5. Place the U brackets inside the HD Side Step. Position the U brackets to align with the mounting brackets.
6. Assemble the 5/16" flat washers, (5/16" lock washers and 5/16" x 1" hex head bolts. This hardware kit is included with the bracket kit (sold separately). See illustration 2.
7. Align the HD Side Step and tighten the bolts using a wrench or socket.

Illustration 1

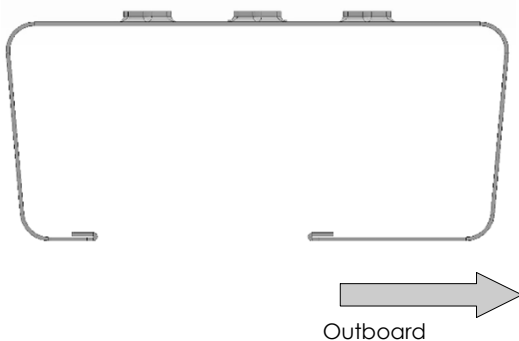
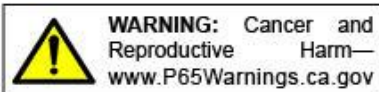
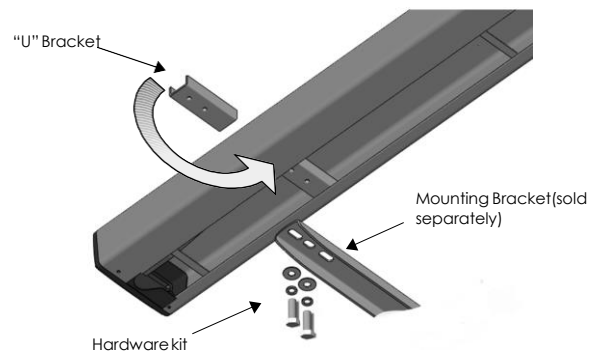

Illustration 2



© 2016 Go Rhino Products. All rights reserved