

banks

with Installation Instructions

Owner's Manual

Banks Monster® Exhaust System

2012-2016 Jeep 3.6L Wrangler 2 Door

THIS MANUAL IS FOR USE WITH MONSTER EXHAUST SYSTEM 51342

Gale Banks Engineering
546 Duggan Avenue • Azusa, CA 91702
(626) 969-9600 • Fax (626) 334-1743

Product Information & Sales: (888) 635-4565
Customer Support: (888) 839-5600
Installation Support: (888) 839-2700

bankspower.com

banks

Products available from Banks Power for the 2012-2016 Jeep 3.6L Wrangler

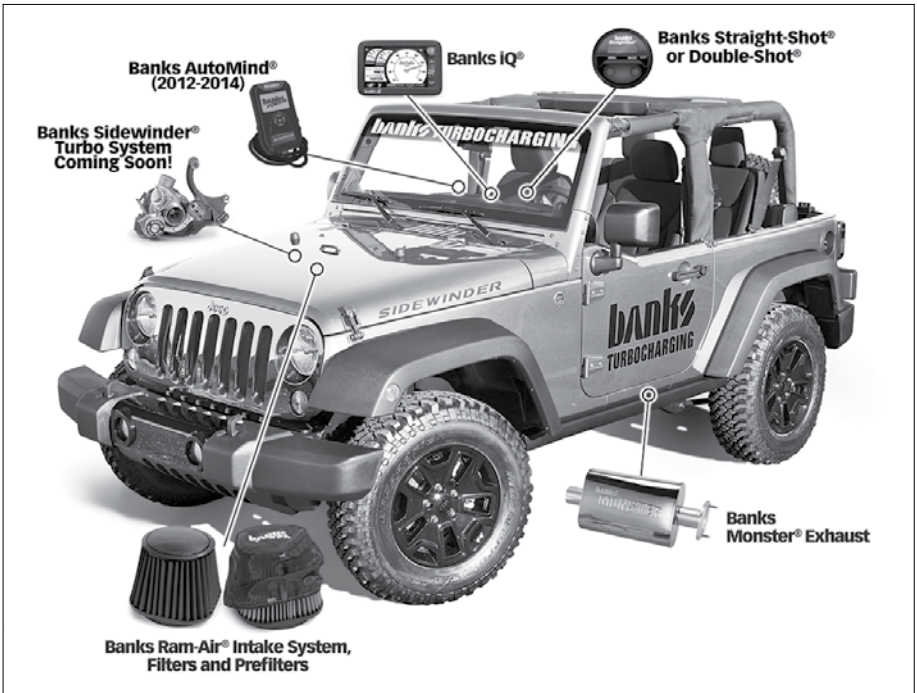

Banks Ram-Air® Intake System (P/N 42215)

- Increases your airflow over stock.
- Adds power, improves fuel economy.

Banks Ram-Air® Oiled Filter Element (P/N 41837)

- High Volume Airflow with Superior Filtration.
- Large, serviceable lifetime filter

Banks Ram-Air® Dry Filter Element (P/N 41837-D)

- High Volume Airflow with Superior Filtration.
- Large, serviceable, Oil-less lifetime filter

Banks Ram-Air® Pre-Filter Element (P/N 42640)

Banks AutoMind® Programmer 2012-2014 (P/N 66114)

- Clear and view OBDII Diagnostic Trouble Codes (DTC).
- Loaded with dyno-proven tuning files
- Speed Limiter adjustment capabilities.

Banks iQ® System (P/N 61201)

- 5" touchscreen interface
- Interchangeable gauge display, read and clear codes, monitor engine diagnostics, log data, time your vehicles runs and much more.

Banks Straight-Shot® Water-Methanol Injection (P/N 45000)

- Maximizes Engine Performance
- Cools Intake Temperatures
- Digital Controller (included)
- Plug-and-Play wiring
- Greater flow than the competition
- Higher Pump Volume than others

Banks Double-Shot® Water-Methanol Injection (P/N 45002)

- The Double-Shot system offers the same benefits of the Straight-Shot and adds a second stage for increased output and control.

Banks Sidewinder® Turbo System (P/N 24248 Non-Intercooled) (P/N 24249 Intercooled)

- Coming soon!

**For more information please call (888) 635-4565
or visit us online at www.bankspower.com**

General Installation Practices

If you have any questions concerning the installation of your Banks Monster Exhaust System, please call our Technical Service Hotline at (888) 839-2700 between 7:00 am and 4:00 pm (PT). If you have any questions relating to shipping or billing, please contact our Customer Service Department at (888) 839-5600.

Thank you.

1. Before starting work, familiarize yourself with the installation procedure by reading all of the instructions.
2. The exploded view (**Figure 1**) provides only general guidance. Refer to each step and section diagram in this manual for proper instruction.
3. Throughout this manual, the left side of the vehicle refers to the driver's side, and the right side to the passenger's side.
4. Disconnect the negative (ground) cable from the battery (or batteries, if there are two) before beginning work.
5. Route and tie wires and hoses a minimum of 6" away from exhaust heat, moving parts and sharp edges. Clearance of 8" or more is recommended where possible.
6. When raising the vehicle, support it on properly weight-rated safety stands, ramps or a commercial hoist. Follow the manufacturer's safety precautions. Take care to balance the vehicle to prevent it from slipping or falling.

When using ramps, be sure the front wheels are centered squarely on the topsides. When raising the front of the vehicle, put the transmission in park, set the parking brake, and block the rear wheels. When raising the back of the vehicle, be sure the vehicle is on level ground and the front wheels are blocked securely.

CAUTION! Do not use floor jacks to support the vehicle while working under it. Do not raise the vehicle onto concrete blocks, masonry or any other item not intended specifically for this use.

7. During installation, keep the work area clean. Do not allow anything to be dropped into intake, exhaust, or lubrication system components while performing the installation, as foreign objects will cause immediate engine damage upon start-up.

Tools Required:

- 1/2" and 3/8" drive ratchets with standard and metric sockets and 1/2" and 3/8" drive extension
- Standard and metric combination or open-end wrenches
- Standard screwdriver
- Clean shop towels or rags
- Pry-bar
- Reciprocating Saw

Highly recommended tools and supplies:

- Foot-pound torque wrench
- Penetrating oil or light lubricant spray

General Assembly

Figure 1

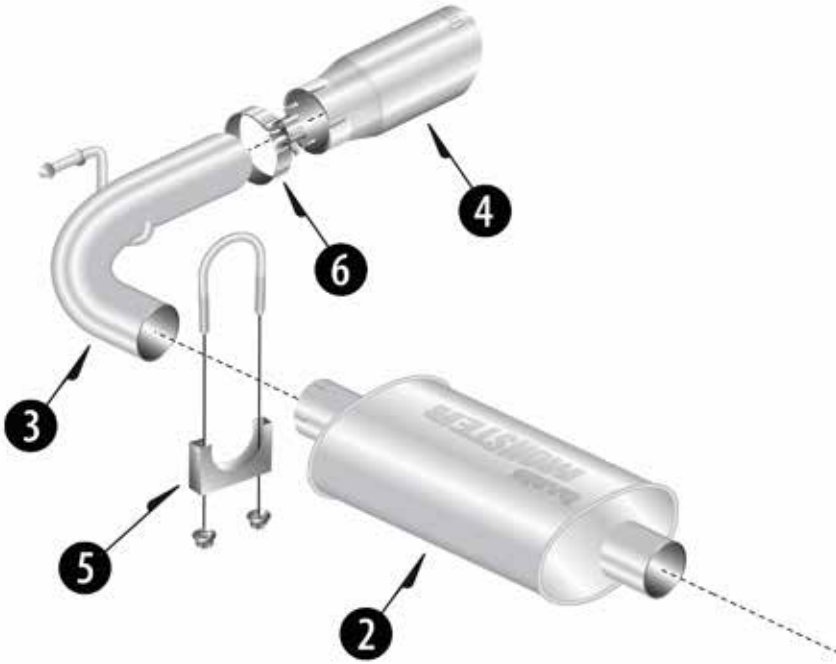

Item #	Description	P/N	QTY
1	Front Tailpipe	52657	1
2	Monster Muffler	52639	1
3	Rear Tailpipe	52659	1
4	Tailpipe Tip, Chrome/Black	52700/52701	1
5	Saddle Clamp, 2.5"	52461	3
6	Band Clamp, 2.5"	52462	1
7	Banks Decal	96009	2

7 **bankz**
POWER

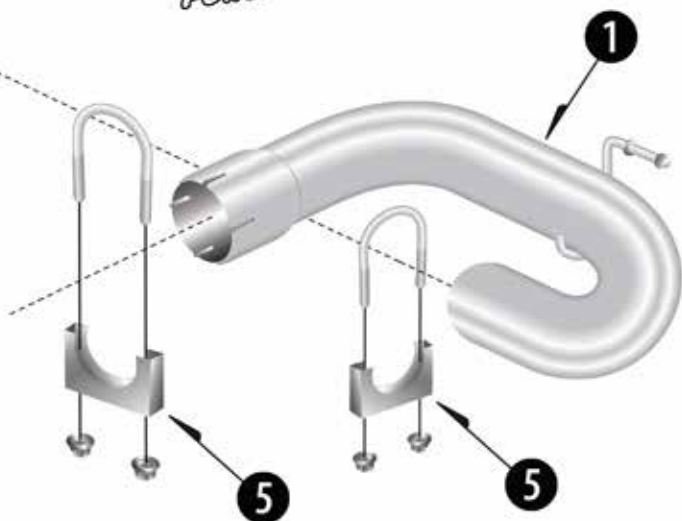

Monster Exhaust System Installation

1. Disconnect the negative (ground) cable from the battery (if there is more than one battery, disconnect both negative cables). Secure the cable so it cannot accidentally come in contact with the post.

2. Raise the vehicle and support it securely with properly weight-rated safety stands, ramps or a commercial hoist. Take care to balance the vehicle to prevent it from slipping or falling. When using ramps, be sure the wheels are centered squarely on the topsides. Place the transmission in park (automatic), set the parking brake and securely block the wheels that are on the ground.

CAUTION: DO NOT WORK UNDER ANY VEHICLE SUPPORTED ONLY BY A JACK. SEVERE INJURY MAY RESULT.

3. Loosen and remove the band clamp from the inlet of the muffler. Remove the front and rear muffler hanger pins from the rubber hangers. Remove the factory muffler from the vehicle. See **Figure 2**.

NOTE: Spray lubricant may assist in hanger pin removal. Rubber hangers can also be removed from the vehicle to assist in muffler removal.

WARNING! The following step may require the use of a torch and/ or saw. Proper safety equipment should be used. Failure to use proper safety equipment may result in severe injury.

4. Measure 10.5" from the rear hanger behind the factory resonator to the rear of the vehicle along the lower part of the tailpipe and mark the location. See **Figure 3**.

Figure 2

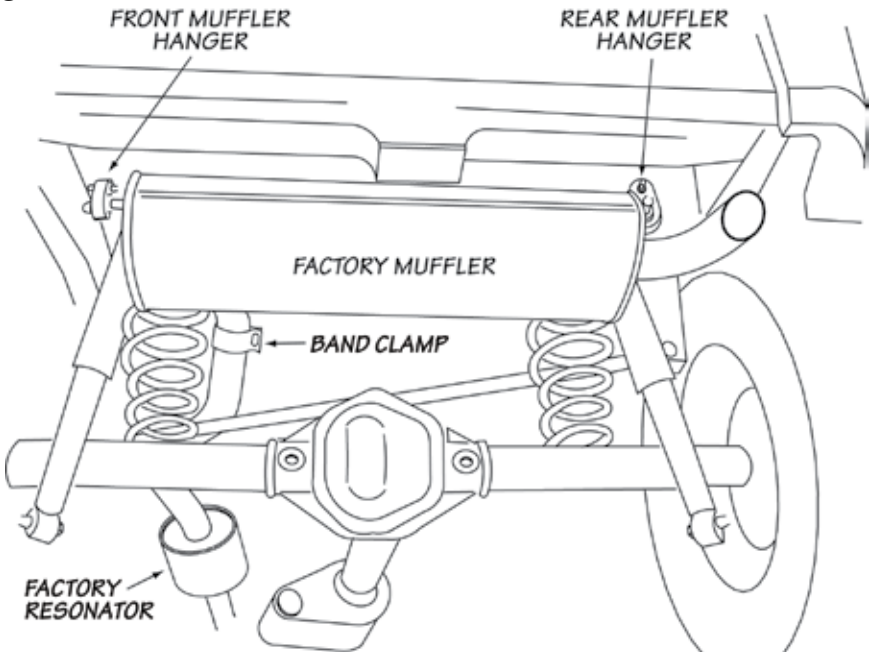
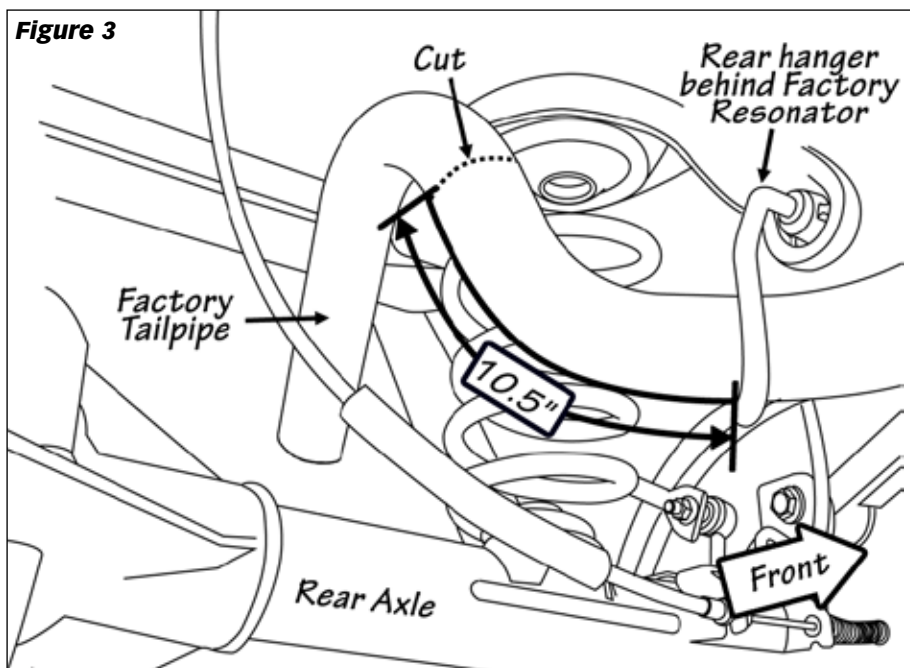

Figure 3



NOTE: Begin cutting just where the tubing begins to bend at the top. Try to leave as much straight tailpipe to receive Banks Front tailpipe.

Using a reciprocating saw, cut the factory tailpipe. Take time when measuring and cutting the factory tailpipe to ensure the proper location and a straight cut. Improper cut will result in poor fitment of the Banks Monster Exhaust system.

NOTE: Gale Banks Engineering has tested and designed this Monster Exhaust System to work with the factory resonator. Keeping the factory straight-through resonator design on the vehicle will not reduce performance and it will help reduce resonance in-cab due to the aggressive camshaft profiles and variable valve timing of the engine design.

5. Place a 2.5" saddle clamp on the inlet of Banks Front tailpipe. From the vehicle rear, route the Front tailpipe over the rear end. Install the Front tailpipe onto the factory tailpipe outlet. Insert Banks hanger pin into the vehicle's rubber hanger. Loosely tighten the 2.5" clamp.

NOTE: All clamps should be positioned at the beginning of the slots (on the 1/2 circle punch).

NOTE: Once the pipe / muffler has been completely engaged in the slip joint, mark the pipe with a scribe or tape for reference when tightening the clamps later in the installation. Mark each slip joint in this fashion.

Figure 4

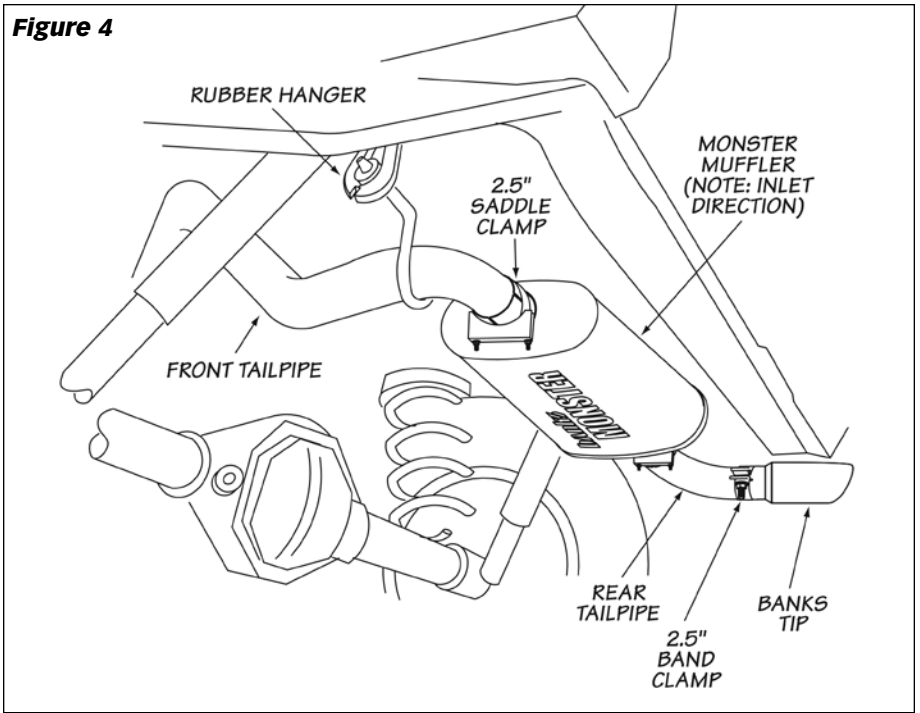

6. Place a 2.5" saddle clamp on the inlet of the Monster Muffler. (Note the inlet labeling of the muffler) Install the Monster Muffler onto the front tailpipe. Orient the Monster Muffler such that it is parallel with the cab and the Monster logo is visible once the exhaust is installed. Loosely tighten the 2.5" clamp (See **Figure 4**)

7. Place a 2.5" saddle clamp on the outlet of the Monster Muffler. Install the rear tailpipe into the Monster muffler. Insert the Banks hanger pin into the vehicle's rubber hanger. Adjust the tailpipe so that it is straight and flat under rear bumper. Loosely tighten the 2.5" clamp.

8. Install the 2.5" band clamp onto the tip inlet. Install the tip and clamp assembly onto the tailpipe outlet.

Adjust the tip to be flat under the body panel, such that the tip position is aesthetically pleasing (See **Figure 4**).

9. Adjust each of the pipes to ensure that all of the hanger pins are parallel with the frame mounted pins and that the rubber hangers are all positioned slightly forward (See **Figure 5**). This allows the hangers to be properly positioned once the exhaust reaches operating temperature.

10. With the exhaust positioned properly, begin to evenly tighten the clamps starting with the ones closest to the front of the vehicle and working your way back. Torque the exhaust clamps evenly to 35 ft-lbs. Make sure that each slip is fully inserted (+/-1/4").

Figure 5

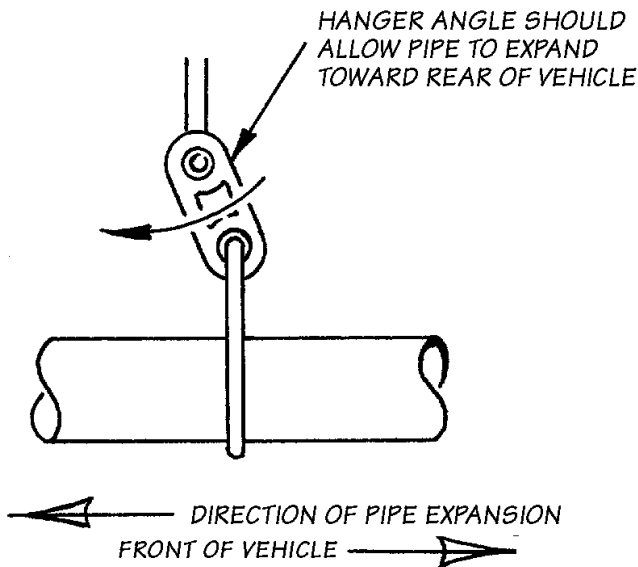

11. Remove the protective covering from the tailpipe tip.

CAUTION: The protective covering may ignite and burn if not removed prior to running the engine.

12. Your system includes two (2) Banks Power logos designed to complement the vehicle's front fenders. See **Figure 6** for recommended logo placement.

13. Re-connect the negative battery cable. Start the engine and listen for exhaust leaks. Tighten the exhaust clamps as necessary. Whenever possible, tack welding slip connections to prevent disengagement is recommended.

14. The Banks Monster Exhaust installation is now complete.

Figure 6

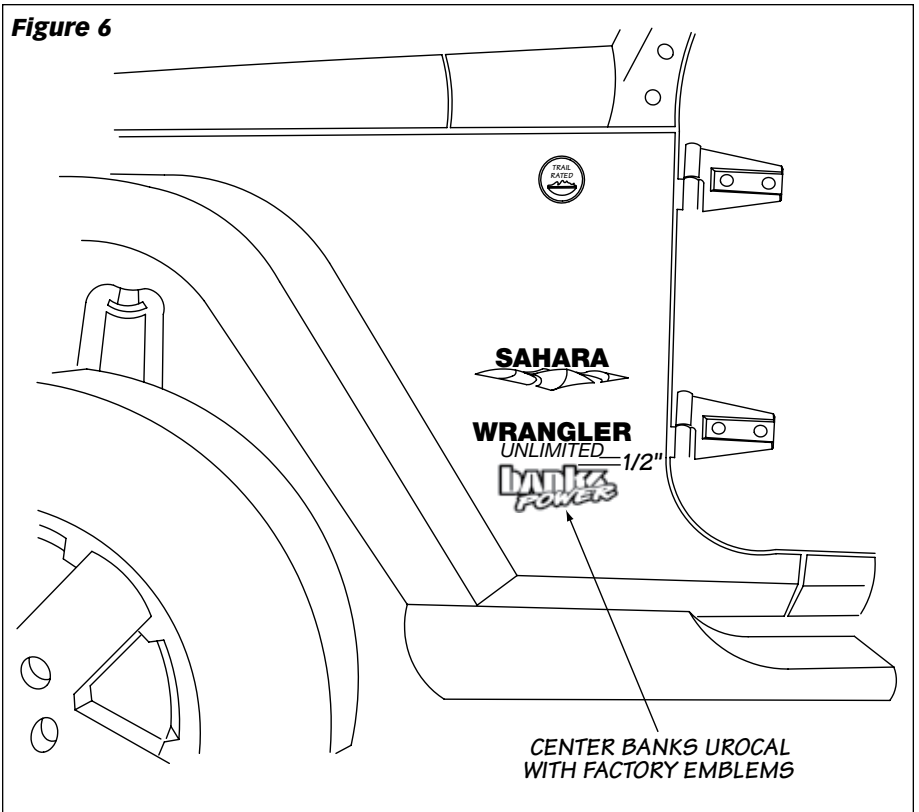

Gale Banks Engineering
546 Duggan Avenue • Azusa, CA 91702
(626) 969-9600 • Fax (626) 334-1743

Product Information & Sales: (888) 635-4565
Customer Support: (888) 839-5600
Installation Support: (888) 839-2700

bankspower.com