



# ***X Flow Intake Manifold***

For 2003-07 Dodge 5.9L Cummins Trucks

Part #	Description
<b>1041555</b>	Intake Horn (Black Powder Coat)
<b>1041555-P</b>	Intake Horn (Polished Aluminum)

## **-- Installation Instructions --**

*PLEASE READ ALL INSTRUCTIONS CAREFULLY BEFORE INSTALLATION.*











BD Engine Brake Inc.

Plant Address: Unit A10, 33733 King Rd, Abbotsford, BC, Canada V2S 7M9

U.S. Shipping Address: 88-446 Harrison St, Sumas, WA 98295 U.S. Mailing Address: P.O. Box 231, Sumas, WA 98295

Phone: 604-853-6096 Fax: 604-853-8749 Internet: [www.bd-power.com](http://www.bd-power.com)

## Kit Contents

<b>1041555 (Black) and/or 1041555-P (Polished) Dodge X-Flow Intake</b>			
<b>1401555</b>	<b>1401555-POL</b>	<b>1401551Z</b>	<b>1401552Z</b>
			
<i>Powder Coated Intake</i> <b>1041555 Kit ONLY</b>	<i>Polished Manifold</i> <b>1041555-P Kit ONLY</b>	<i>Long Stud</i>	<i>Short Stud</i>
<b>Qty: 1</b>	<b>Qty: 1</b>	<b>Qty: 2</b>	<b>Qty: 2</b>
<b>1401553</b>	<b>1401554</b>	<b>1401556</b>	<b>3969988</b>
			
<i>M8 JIS Flange Nut</i>	<i>M8 Acorn Nut</i>	<i>M8 Washer</i>	<i>Intake Gasket</i>
<b>Qty: 2</b>	<b>Qty: 2</b>	<b>Qty: 2</b>	<b>Qty: 1</b>
<b>1130055</b>	<b>1200208</b>		
			
<i>Jam Nut</i>	<i>1/8" NPT Plug</i>		
<b>Qty: 1</b>	<b>Qty: 1</b>		

BD Engine Brake Inc.

Plant Address: Unit A10, 33733 King Rd, Abbotsford, BC, Canada V2S 7M9

U.S. Shipping Address: 88-446 Harrison St, Sumas, WA 98295 U.S. Mailing Address: P.O. Box 231, Sumas, WA 98295

Phone: 604-853-6096 Fax: 604-853-8749 Internet: [www.bd-power.com](http://www.bd-power.com)

## Installation

Remove the factory intake elbow, and remove the silicon boot hose clamp with a 7/16" wrench. Use a 10mm socket to remove the oil dipstick mount. Be sure to save this bolt as it will be re-used later.

You can also remove the four other mounting bolts that secure the intake manifold in place.

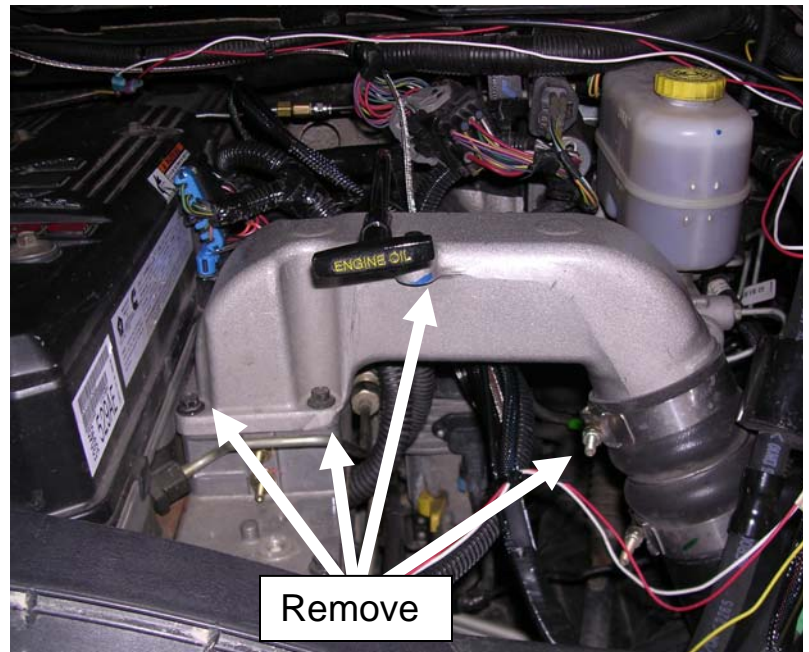

On the rear of the intake you will notice a wiring harness bolted to the intake. You will need to remove the nut and washer that secure the wiring harness to the intake.

You can now lift and remove the intake elbow.

With the intake elbow now out of the truck, remove the wiring harness mounting stud and install it into the BD intake elbow.



BD Engine Brake Inc.

Plant Address: Unit A10, 33733 King Rd, Abbotsford, BC, Canada V2S 7M9

U.S. Shipping Address: 88-446 Harrison St, Sumas, WA 98295 U.S. Mailing Address: P.O. Box 231, Sumas, WA 98295

Phone: 604-853-6096 Fax: 604-853-8749 Internet: [www.bd-power.com](http://www.bd-power.com)

You will now need to scrape off any left-over gasket material that resides on the intake heater.

***Be sure that no media falls into the intake.***

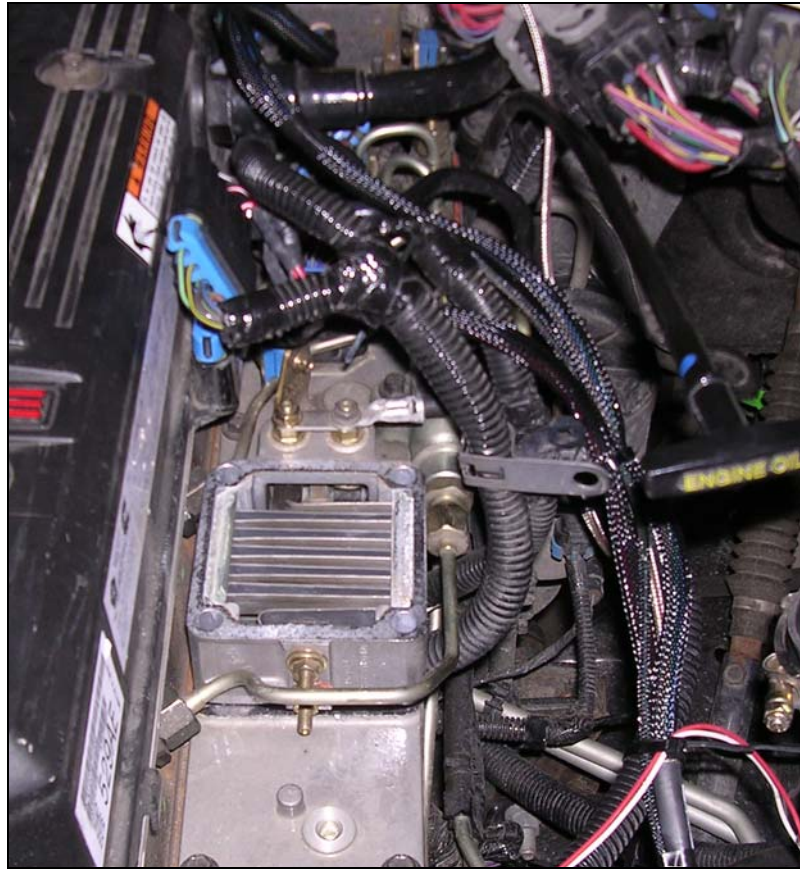

Place the new gasket (supplied) in place on top of the intake heater.

You can now thread in the mounting studs. The long studs are mounted in the threaded holes closest to the valve cover. Note that before installing these studs you will need to cover the studs with pipe dope or another thread sealer.

Install the shorter studs in the two remaining threaded holes.



BD Engine Brake Inc.

Plant Address: Unit A10, 33733 King Rd, Abbotsford, BC, Canada V2S 7M9

U.S. Shipping Address: 88-446 Harrison St, Sumas, WA 98295 U.S. Mailing Address: P.O. Box 231, Sumas, WA 98295

Phone: 604-853-6096 Fax: 604-853-8749 Internet: [www.bd-power.com](http://www.bd-power.com)

**With the jam nut supplied you will need to double nut each stud and torque the stud down in place to 3 lbs-ft. You must make sure that the threads are fully seated in place. Once it has been torqued, you can remove the two nuts.**

**Note that the end with the shorter length of thread, should be inserted into the head.**

With the studs torqued, it is suggested that you unplug the fuel pressure sensor and the wiring harness for the injectors on cylinders 3 & 4. This should allow a little more room.

To ease the installation, you can remove the mounting bolt that secures the dipstick tube in place to the engine block. It is located about 24" from the front of the tube.

Drop the BD intake manifold in place over the studs. You may need some assistance in moving the dipstick out of the way.

Before installing the elbow in place, you can thread in the supplied 1/8" NPT plug, or, install the boost pressure line in its place.



*Tighten the Acorn nut onto the jam nut.*

Move the intake around so that it is not touching anything and secure the intake with the supplied nuts. Note that the 12mm JIS nuts should be mounted to the smaller studs on the driver's side of the intake, while the 13mm Acorn nuts should be mounted to the longer studs. Be sure to place the washers underneath the Acorn nuts.

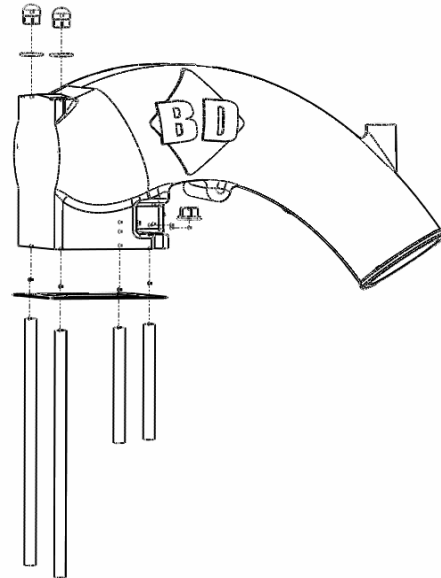

Torque the nuts to **13 ft-lbs**.

Reuse the factory dipstick tube mounting bolt to secure the dipstick to the intake.

Reconnect the wiring harnesses from the fuel pressure sensor and the injectors. You can secure this wiring harness to the factory mounting stud. You will need to re-use the washer and nut that you removed earlier.

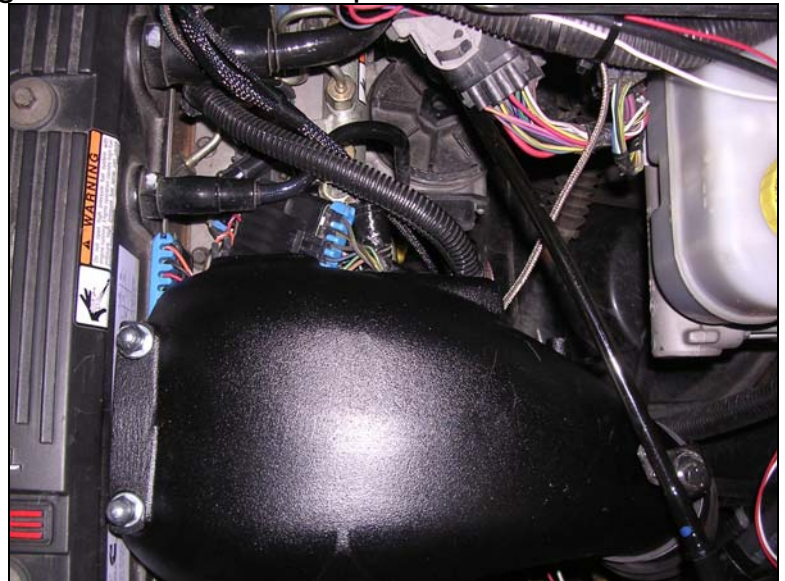

You can now reconnect the factory silicone boot and clamp. Be sure to clean the inside of the silicone boot with either a non oil based electrical contact cleaner or brake clean.

BD Engine Brake Inc.

Plant Address: Unit A10, 33733 King Rd, Abbotsford, BC, Canada V2S 7M9

U.S. Shipping Address: 88-446 Harrison St, Sumas, WA 98295 U.S. Mailing Address: P.O. Box 231, Sumas, WA 98295

Phone: 604-853-6096 Fax: 604-853-8749 Internet: [www.bd-power.com](http://www.bd-power.com)

## **BD ENGINE BRAKE DISCLAIMER OF LIABILITY**

Other than as expressly set forth herein, BD ENGINE BRAKE, Inc. (hereafter collectively, "SELLER"), together with its distributors, jobbers and dealers shall in no way be responsible for the PRODUCT'S proper use and service. In no event shall SELLER be liable for any special, incidental, indirect or consequential damages of any kind or nature, whether or not BUYER was advised of the possibility of damage, arising or resulting from the use or performance of the PRODUCT, and BUYER hereby waives any and all such claims.

BUYER acknowledges that he/she/it is not relying on SELLER'S skill or judgment to select or furnish goods suitable for any particular purpose and that SELLER has no liability that will extend beyond the scope of the limited warranty contained herein, and BUYER hereby waives all remedies or liabilities, expressed or implied, arising by operation of law or otherwise, (including, without limitation, any obligations of SELLER with respect to fitness for any particular purpose; merchantability; and special, incidental, indirect or consequential damages) or whether or not occasioned by SELLER'S negligence.

SELLER disclaims any warranty and expressly disclaims any liability for personal injury or damages related to BUYER'S use of the PRODUCT. BUYER acknowledges and agrees that the disclaimer of any liability for personal injury is a material term for this agreement and BUYER agrees to indemnify SELLER and hold SELLER harmless from any claim related to the PRODUCT and its use or performance. Under no circumstances will SELLER be liable for any damages, liabilities, costs or expenses incurred as a result of by reason of the use, performance or sale of the PRODUCT, including, without limitation, any damages, liabilities, costs or expenses incurred by reason of BUYER'S negligence related to those uses of the PRODUCT as a result of the removal of the speed limiter.

SELLER assumes no liability regarding the improper installation or misapplication of the PRODUCT. It is the installer's responsibility to check for proper installation, and, if in doubt, contact the manufacturer.

### **LIMITATION OF WARRANTY**

SELLER hereby provides the following limited warranty as to description, quality, merchantability, fitness for any product's purpose, productiveness, or any other matter of SELLER'S product sold herewith. The SELLER shall be in no way responsible for the product's open use and service and the BUYER hereby waives all rights other than those expressly written herein. This Warranty shall not be extended or varied except by a written instrument signed by SELLER and BUYER.

The Warranty is Limited to one (1) year from the date of sale and limited solely to the parts contained within the product's kit. All products that are in question of Warranty must be returned shipping prepaid to the SELLER and must be accompanied by a dated proof of purchase receipt. All Warranty claims are subject to approval by BD ENGINE BRAKE, Inc.

Under no circumstances shall the SELLER be liable for any labor charged or travel time incurred in diagnosis for defects, removal, or reinstallation of this product, or any other contingent expenses.

Under no circumstances will the SELLER be liable for any damage or expenses insured by reason of the use or sale of any such equipment.

IN THE EVENT THAT THE BUYER DOES NOT AGREE WITH THIS AGREEMENT: THE BUYER MAY PROMPTLY RETURN THIS PRODUCT, IN A NEW AND UNUSED CONDITION, WITH A DATED PROOF OF PURCHASE, TO THE PLACE OF PURCHASE WITHIN THIRTY (30) DAYS FROM DATE OF PURCHASE FOR A FULL REFUND. THE INSTALLATION OF THIS PRODUCT INDICATES THAT THE BUYER HAS READ AND UNDERSTANDS THIS AGREEMENT AND ACCEPTS ITS TERMS AND CONDITIONS.

BD Engine Brake Inc.

Plant Address: Unit A10, 33733 King Rd, Abbotsford, BC, Canada V2S 7M9

U.S. Shipping Address: 88-446 Harrison St, Sumas, WA 98295 U.S. Mailing Address: P.O. Box 231, Sumas, WA 98295

Phone: 604-853-6096 Fax: 604-853-8749 Internet: [www.bd-power.com](http://www.bd-power.com)