



EZ - Ride Suspension

Part # 16958
2001 — 2005 Chevy or GMC 1500 Heavy Duty
6" Suspension system

Parts contained in Box 1 of 3

Part #	Description	Qty.
16985-04	One piece lower sub frame	1
16985-12	Lateral compression arms	2
16985NB	Hardware box	1

Parts contained in Box 2 of 3

Part #	Description	Qty.
HDDIFF-01	DS differential relocation bracket	1
16985-07	PS differential relocation bracket	1
16958-16	Torsion bar cross member relocation brackets	2
16985-10	Rear carrier bearing relocation bracket	1
16985-11	Lateral compression arm mounts	2
22SW	2" x 2" square washers	8
BL402	Rear lifted blocks	2
5U-9296S	5/8" x 2 3/4" x 14" square u-bolt	4
58NW	Hardware bag	1
16985PL	Hardware bag	1
16985SL	Hardware bag	1
9802	CV axle spacers	2
S10120	DS differential spacer sleeve	1
SHOCKTIE	Shock ties	10
DECAL	Window sticker	1
16958INST	Instruction sheet (customer copy)	1
16958INST	instruction sheet (installer copy)	1
MIRRORHANGER	Rear view mirror hanger	1
WARNIGNDECAL	Warning decal	1

Parts contained in Box 3 of 3

Part #	Description	Qty.
16985-01M	Driver side knuckle	1
16985-02M	Passenger side knuckle	1

Congratulations on your selection to purchase a Tuff Country EZ-Ride Suspension System. We at Tuff Country EZ-Ride Suspension are proud to offer a high quality product at the industries most competitive pricing. Thank you for your confidence in us and our product.

For a list of all parts, please refer to the Parts Description Page, at the end of the Installation Manual.

The Tuff Country EZ-Ride Suspension product safety label that is included in your kit box must be installed inside the cab in plain view of all occupants.

Installation manual 6" Suspension system 2001 — 2005 Chevy or GMC 1500 Heavy Duty Part # 16958

sj051206rev.01

Tuff Country EZ-Ride Suspension highly recommends that a qualified or a certified mechanic performs this installation.

If you desire to return your vehicle to stock, it is the customers responsibility to save all stock hardware.

It is the responsibility of the customer or the mechanic to wear safety glasses at all times when performing this installation.

It is the customers/installers responsibility to read and understand all steps before installation begins. OEM manual should be used as a reference guide.

This vehicles reaction and handling characteristics may differ from standard cars and/or trucks. Modifications to improve and/or enhance off road performance may raise the intended center of gravity. Extreme caution must be utilized when encountering driving conditions which may cause vehicle imbalance or loss of control. DRIVE SAFELY! Avoid abrupt maneuvers: such as sudden sharp turns which could cause a roll over, resulting in serious injury or death.

It is the customers responsibility to make sure that a re-torque is performed on all hardware associated with this suspension system after the first 100 miles of installation. It is also the customers responsibility to do a complete re-torque after every 3000 miles or after every off road use.

After the original installation, Tuff Country EZ-Ride Suspension also recommends having the alignment checked every 6 months to ensure proper tracking, proper wear on tires and front end components. Tuff Country EZ-Ride Suspension takes no responsibility for abuse, improper installation or improper suspension maintenance.

It is the responsibility of the installers to make sure that the rear view mirror hanger is hung from the rear view mirror. The rear view mirror hanger has instructions on proper post installation procedure.

Make sure to use thread locker or locktite on all new and stock hardware associated with the installation of this suspension system.

Limited lifetime warranty

Notice to all Tuff Country EZ-Ride Suspension customers: It is your responsibility to keep your original sales receipt! If failure should occur on any Tuff Country EZ-Ride Suspension component, your original sales receipt must accompany the warranted unit to receive warranty. Warranty will be void if the customer can not provide the original sales receipt. Do not install a body lift in conjunction with a suspension system. If a body lift is used in conjunction with any Tuff Country EZ-Ride Suspension product, your Tuff Country EZ-Ride Suspension WARRANTY WILL BE VOID. Tuff Country Inc. ("Tuff Country") suspension products are warranted to be free from defects in material and workmanship for life if purchased, installed and maintained on a non-commercial vehicle; otherwise, for a period of twelve (12) months, from the date of purchase and installation on a commercial vehicle, or twelve thousand (12,000) miles (which ever occurs first). Tuff Country does not warrant or make any representations concerning Tuff Country Products when not installed and used strictly in accordance with the manufacturer's instructions for such installation and operation and accordance with good installation and maintenance practices of the automotive industry. This warranty does not apply to the cosmetic finish of Tuff Country products nor to Tuff Country products which have been altered, improperly installed, maintained, used or repaired, or damaged by accident, negligence, misuse or racing. ("Racing is used in its broadest sense, and, for example, without regards to formalities in relation to prizes, competition, etc.) This warranty is void if the product is removed from the original vehicle and re-installed on that or any other vehicle. This warranty is exclusive and is in lieu of any implied warranty of merchantability, fitness for a particular purpose or other warranty of quality, whether express or implied, except the warranty of title. All implied warranties are limited to the duration of this warranty. The remedies set forth in this warranty are exclusive. This warranty excludes all labor charges or other incidental or consequential damages. Any part or product returned for warranty claim must be returned through the dealer of the distributor from whom it was purchased. Tuff Country reserves the right to examine all parts returned to it for warranty claim to determine whether or not any such part has failed because of defect in material or workmanship. The obligation of Tuff Country under this warranty shall be limited to repairing, replacing or crediting, at its option, any part or product found to be so defective. Regardless of whether any part is repaired, replaced or credited under this warranty, shipping and/or transportation charges on the return of such product must be prepaid by the customer under this warranty.

Important information that needs to be read before installation begins;

Tuff Country EZ-Ride Suspension recommends the use of an 8" wheel once part # 16958 has been installed on a vehicle. If any wheel wider than a 8" wheel is used, rubbing on the inner fender wheel and plastic valance will occur.

After the installation is complete, a front end alignment is required. Also, some vehicles may need to have an exhaust modification performed.

After completion of the installation and the new tires and wheels have been installed, trimming of the plastic valance may be needed. Slight trimming may be needed when installing a 35 x 12.50.

Before installation begins, Tuff Country EZ-Ride Suspension highly recommends that the installer performs a test drive on the vehicle. During the test drive, check to see if there are any uncommon sounds or vibrations. If uncommon sounds or vibrations occur on the test drive, uncommon sounds or vibrations will be enhanced once the suspension system has been installed. Tuff Country EZ-Ride Suspension highly recommends notifying the customer prior to installation to inform the customer of these issues if they exist.

New longer front and rear shocks are needed after this suspension system has been installed and the front and rear shocks need to be ordered as a separate part #. If you have not already ordered your front and rear shocks, please feel free to contact Tuff Country or your local Tuff Country dealer and order your front and rear shocks.

Once the installation is complete and a front end alignment has been performed, test drive the vehicle to see if there are any front drive line vibrations. If front drive line vibration occurs, take the front drive line to a drive line shop and have the front drive line re-balanced.

Hardware bag 16985SL includes:

Description	Quantity
S10007 (.500" x .380" x 1.700")	2
S10058 (.875" x .500" x 2.080")	4
S10067 (.500" x .375" x 2.610")	2
S10073 (.690" x .560" x 1.320")	2
S10074 (.700" x .563" x 1.500")	4
S10082 (.875" x .563" x 2.080")	1

Hardware bag 16985PL includes:

Description	Quantity
PBBS1 (Poly bump stops)	4
PBBS2 (Poly bump stops)	2
PB2408 (Poly bushings)	10
PB4902 (Poly bushings)	4
PB8016 (Poly bushings)	8
S10049 (Washers)	8
PB8297 (poly bushings)	4
S10107 (oversize washer)	4
LUBE (poly lube packs)	2

Hardware bag 16985NB includes:

Bag # 1

Description	Quantity
3/8" x 1 1/2" self threading bolts	2
3/8" x 3 1/2" bolts	2
3/8" x 7" bolts	2
3/8" unitorque nuts	10
5/16" USS flat washers	10
10 mm x 35 mm bolt	12
10 mm x 60 mm bolt	4
10 mm lock washers	16
1/4" x 1" self threading bolt	1

Bag # 2

Description	Quantity
7/16" x 1 1/2" bolts	10
7/16" x 3" bolts	1
7/16" unitorque nuts	11
3/8" USS flat washers	22

Bag # 3

Description	Quantity
1/2" x 2" bolts	4
1/2" x 3 1/2" bolts	4
1/2" unitorque nuts	8
7/16" USS flat washers	16

Bag # 4

Description	Quantity
9/16" x 1 3/4" bolts	2
9/16" unitorque nuts	2
1/2" USS flat washers	4

Bag # 5

Description	Quantity
5/8" x 4 1/2" bolts	2
5/8" x 5 1/2" bolts	2
5/8" unitorque nuts	4
9/16" USS flat washers	8

Hardware Bag 58NW Includes:

Description	Quantity
5/8" U-bolt high nuts	8
5/8" U-bolt harden washers	8

Special note: Before installation begins, it is the customers/installers responsibility to make sure that all parts are on hand. If any parts are missing, please feel free to call one of our customer service representatives @ (801) 280-2777.

Special post installation procedure: Tuff Country EZ-Ride Suspension highly recommends adding a minimum of 1 pint, but no more that 1 1/2 pints, of proper front differential fluid into the front differential. To achieve this, you may have to fill the differential with it on its side or you may have to insert the fluid through the vend tube opening. On occasion, the customer may find burping of fluid coming out of the front vent tube.

Please follow instructions carefully:

Before installation begins, measure from the center of the hub, to the bottom of the fender well, and record measurements below.

Pre-installation measurements:

Driver side front: _____

Passenger side front: _____

Driver side rear: _____

Passenger side rear: _____

At the end of the installation, take the same measurements and compare to the pre-installation measurements.

Post-installation measurements:

Driver side front: _____

Passenger side front: _____

Driver side rear: _____

Passenger side rear: _____

1. To begin installation, block the rear tires of the vehicle so that the vehicle is stable and can't roll backwards. Safely lift the front of the vehicle, and support the frame with a pair of jack stands. Place a jack stand on both the driver and passenger side. Next, remove the tires and wheels from both sides.

2. Remove the stock front upper and lower skid plates. The stock lower skid plate and stock hardware may be discarded. Save the stock upper skid plate and the (3) stock upper bolts for later re-installation.

3. Remove the stock front driveline from the stock location on the front differential and the transmission. Save the stock driveline and hardware for later re-installation.

4. Working on the driver side, remove the stock hardware on the top of the stock shock. The upper stock hardware may be discarded. Remove the stock hardware on the lower shock mount and save the stock hardware for later re-installation. The stock shock may be discarded. **Special note: New longer front shocks are needed, if you have not already ordered shocks, please contact Tuff Country or your local Tuff Country dealer and order the proper shocks. Tuff Country recommends using a 23" fully extended nitrogen gas shock.** Repeat procedure on the passenger side.

5. Measure the exposed threads on the torsion bar adjustment bolt and record measurement here for a later reference.

Record driver side measurement here: _____

Record passenger side measurement here: _____

Photo # 1

6. Working on the driver side, attach the torsion bar removing tool to the stock torsion bar cross member, making sure that the unloading bolt in the center of the torsion bar removing tool is in the small divot of the stock torsion bar key. Adjust the torsion bar key up high enough so that the stock small metal adjusting block and bolt can be removed. Set the stock torsion bar block and hardware a side for later re-installation. Repeat procedure on passenger side.

7. Mark both torsion bars before removal so that they can be re-installed back into the same location. **Example: driver vs. passenger and front vs. rear.** Tap the stock torsion bars forward until the stock torsion bar cross member can be removed. Once you tap the stock torsion bar out of the stock torsion bar cross member, the stock torsion bar key will fall out. Set the stock torsion bar key a side for later re-installation. Repeat procedure on the passenger side.

8. Working on the driver side, remove the stock hardware that connects the stock torsion bar cross member to the stock mounting point. Set the stock hardware a side for later re-installation. **Special note: The stock mounting point is on the inside of the stock frame rail.** Repeat procedure on the passenger side. Remove the stock torsion bar cross member from the stock location and set a side for later re-installation.

9. Working on the driver side, slide the stock torsion bar out of the stock rear lower control arm and set a side for later re-installation. Repeat procedure on passenger side.

10. Working on the driver side, remove the stock sway bar end link from the stock location and discard the stock end link and all the stock hardware. Repeat procedure on the passenger side. **Special note: At this time, invert the stock sway bar.**

11. Working on the driver side, remove the stock nut that connects the stock outer tie rod ball joint to the stock steering knuckle. Set the stock nut a side for later re-installation. Carefully break the stock taper on the stock outer tie rod ball joint and remove the stock outer tie rod from the stock knuckle. **Special note: Take special care not to rip or tear the stock outer tie rod ball joint dust boot.**

12. Working on the driver side, remove the stock brake line bracket that connects to the stock steering knuckle and discard the stock hardware. Next, remove the stock brake line mounting point that connects to the stock upper control arm. Save the stock hardware for later re-installation. Also, remove any other brake line mounting points on the stock steering knuckle and stock upper control arm.

13. Working on the driver side, locate the ABS line quick disconnect located above the stock upper control arm.

Disconnect the ABS lines from each other. Also, disconnect the ABS line from any other mounting points.

14. Working on the driver side, remove the (2) stock bolts that connect the stock brake caliper to the stock knuckle. Save the stock hardware for later re-installation. Using a bungee cord, carefully tie the stock brake caliper up and out of the way in the fender well. **Special note: Take special care not to kink or over extend the stock brake line.**

15. Working on the driver side, remove the stock rotor and set a side for later re-installation.

16. Working on the driver side, remove the stock cap right in the middle of the stock hub assembly. Set the stock cap a side for later re-installation.

17. Working on the driver side, remove the stock hardware that connects the stock axle to the stock hub assembly. Save the stock hardware for later re-installation.

18. Working on the driver side, scribe a mark on the CV plate and another directly across to the stock differential. This will allow you to re-install the stock CV back into the stock location at a later step.

Photo # 2

19. Working on the driver side, remove the (6) stock bolts holding the inner CV axle to the stock front differential. The stock hardware may be discarded. Carefully remove the stock CV axle from the stock location and set the stock CV axle a side for later re-installation. **Special note: During the removal of the stock CV axle, take special care not to damage the threads of the CV axle or the CV axle dust boot.**

20. Working on the driver side, loosen but do not remove the stock nut that connects the stock upper control arm ball joint to the stock steering knuckle. Carefully break the stock taper by striking the stock knuckle with a hammer. **Special note: Take special care not to damaged the stock upper control arm ball joint or rip the stock upper control arm ball joint dust boot.** For now, leave the stock upper control arm attached to the stock knuckle. We want to just break the stock taper for now.

21. Working on the driver side, loosen but do not remove the stock nut that connects the stock lower control arm ball joint to the stock steering knuckle. Carefully break the stock taper by striking the stock knuckle with a hammer. **Special note: Take special care not to damaged the stock lower control arm ball joint or rip the stock lower control arm ball joint dust boot.** For now, leave the stock lower control arm attached to the stock knuckle. We want to just break the stock taper for now.

22. Working on the driver side, move back to the stock nuts holding the stock upper control arm ball joint and the stock lower control arm ball joint to the stock steering knuckle and remove completely. Save the stock hardware for later re-installation. Carefully remove the stock hub assembly and the stock steering knuckle from the stock location and set a side for later re-installation.

23. Working on the driver side stock hub assembly, remove the (4) stock bolts that connect the stock hub assembly to the stock steering knuckle. Save the stock hardware and stock hub assembly for later re-installation. Also, carefully remove the stock rubber "O" ring located in the stock steering knuckle and save for later re-installation. A new steering knuckle is used, the stock steering knuckle can be discarded.

24. Locate the new driver side steering knuckle. Using the stock rubber "O" ring that was removed in step # 23, carefully re-install the stock rubber "O" ring into the new driver side knuckle. Using the stock hardware that was removed from step # 23, secure the new driver side steering knuckle to the stock hub assembly. **Special note: Make sure that the ABS line fits in the groove of the new steering knuckle once the hub assembly has been torqued down. Torque to 133 ft lbs. Make sure to use thread locker or lock tite.**

Photo # 3

25. Set the new driver side steering knuckle and hub assembly a side for later re-installation.

26. Working on the driver side, remove the stock front and rear hardware that connects the stock lower control arm to the stock location. Set the stock hardware and the stock lower control arm a side for later re-installation.

27. Repeat step's 11 - 26 on the passenger side.

28. Working on the driver side, remove the stock bolt that connects the lower rear portion of the stock front differential to the stock rear cross member. Save the stock hardware for later re-installation.

Photo # 4

29. Working on the passenger side, remove the (2) stock bolts that connect the stock rear cross member to the stock passenger side rear lower control arm mounting point. The (2) stock bolts may be discarded.

Photo # 5

30. Working on the driver side, measure 2" towards the inside of the vehicle from the stock rear lower control arm mounting point, scribe a mark on the stock rear cross member. Using a hacksaw or suitable cutting tool, carefully cut off the stock rear cross member along the line that was scribed earlier in this step. The stock rear cross member may be discarded. **Special note: When making this cut, make sure that you cut all the way through the stock rear lower control arm mounting**

point. If this cut is not performed properly, the stock front differential will not seat properly when the front differential is lowered into the new one piece lower sub frame. Also, Tuff Country EZ-Ride highly recommends not using a cutting torch when performing step # 30. Clean and dress up any exposed metal.

Photo # 6

31. Working on the driver side, carefully cut flush, the remainder of the stock rear cross member that is located on the rear portion of the stock rear lower control arm mounting bracket. **Special note: Take special care not to cut into the stock rear lower control arm mounting bracket. Tuff Country recommends not using a cutting torch when performing step # 31. Clean and dress up any exposed metal.**

32. Locate the wiring harness that connects the 4WD control panel to the front differential. Disconnect the 4WD wiring harness from the front differential. Tie the 4WD wiring harness up and out of the way. **Special note: Take special care not to kink any wiring.**

Photo # 7

33. Place a pair of hydraulic floor jacks under the front differential, and carefully raise up on both hydraulic floor jacks at the same time, until they come into contact with the front differential.

34. Disconnect any other vent hoses and/or wiring that is connected to the front differential.

35. Working on the driver side, remove the stock hardware that connects the upper driver side tab of the stock front differential to the stock location. Save the stock hardware for later re-installation.

36. Working on the passenger side, remove the (2) stock nuts that connect the passenger side of the stock front differential to the stock location and save the stock hardware for later re-installation.

37. Carefully lower down on both hydraulic floor jacks at the same allowing enough room to remove the front differential completely from the vehicle. With the help from a buddy, carefully remove the front differential completely from underneath the vehicle and set the stock front differential on the ground or on a work bench.

38. Working on the driver side of the stock front differential upper tab, measure 2" from the stock mounting point and scribe a mark on the stock front differential. Using a sawzall, carefully cut the upper tab off of the stock front differential and discard.

Photo # 8 / side view

Photo # 9 / pre cut view

Photo # 10 / nose cut off of the front differential

39. Locate the new driver side differential relocation

bracket. Locate (2) PB2408 poly bushings from hardware bag 16985PL and (1) S10082 crush sleeve from hardware bag 16985SL. Install the new poly bushings and crush sleeve into the new driver side differential relocation bracket. **Special note: Make sure to use a lithium or moly base grease prior to inserting the new bushings into the new driver side differential relocation bracket. This will increase the life of the bushing as well as prevent squeaking.**

40. Locate (1) 7/16" X 3" bolt, (1) 7/16" unitorque nut, (2) 3/8" USS flat washers, (4) 10 mm x 60 mm bolts and (4) 10 mm lock washers from hardware bag 14985NB. Also, locate the S10120 that is packaged with the installer copy of the installation manual. Remove the (4) stock differential mounting bolts that connect to two halves of the front differential together. The stock hardware may be discarded. Secure the new driver side differential relocation bracket to the stock front differential using the new 10 mm x 60 mm bolts and hardware. **Special note: Get all (4) new 10 mm x 60 mm bolts started but do not tighten at this point and make sure to use thread locker or lock tite.** Secure the lower portion of the new driver side differential relocation bracket to the stock front differential using the new 7/16" x 3" bolt and hardware. **Special note: Make sure to install the new S10120 sleeve between the new driver side differential relocation bracket and the front differential. Also, you will notice that there are (2) holes in the new driver side differential relocation bracket where the new S10120 sleeve will go, we need to match the hole that is on the front differential.** Torque to **34 ft. lbs.** Go back to the (4) new 10 mm x 60 mm bolts that hold the new driver side differential relocation bracket to the stock front differential and torque to **34 ft lbs.** **Special note: Do not use an air gun when installing the new hardware. Make sure not to over tighten the stock and new hardware associated with the front differential. If bolts are over tightened, the stock front differential could crack. Also, Tuff Country EZ-Ride Suspension highly recommends adding a minimum of 1 pint, but no more that 1 1/2 pints, of proper front differential fluid into the front differential. To achieve this, you may have to fill the differential with it on its side or you may have to insert the fluid through the vend tube opening. On occasion, the customer may find burping of fluid coming out of the front vent tube.**

41. Locate the new passenger side differential drop bracket and the stock hardware that was removed from step # 36. Working on the passenger side, install the new passenger side differential relocation bracket into the stock upper location and secure using the stock hardware. **Special note: Make sure to use thread locker or lock tite and do not tighten at this point. Also, there is a "F" cut out in this bracket, the "F" will go towards the front of the vehicle and also if you are standing on the passenger side wheel well looking at the new passenger side differential relocation bracket, you should not be able to see the mounting**

hardware. This will help you make sure that the bracket is installed properly.

Photo # 11

42. With the help from a buddy, carefully lift the modified front differential back onto a pair of hydraulic floor jacks and move the hydraulic floor jacks back underneath the vehicle so that the newly modified front differential can be re-installed.

43. Locate (2) 9/16" x 1 3/4" bolts, (4) 1/2" USS flat washers and (2) 9/16" unitorque nuts from hardware bag 16985NB4. Carefully install the passenger side of the stock front differential to the previously installed passenger side differential drop bracket. Secure using the new 9/16" x 1 3/4" bolts and hardware. **Do not tighten at this point and make sure to use thread locker or lock tite.**

44. Working on the driver side, using a tie down strap or bungee cord, carefully tie the driver side of the stock front differential up and out of the way so that the new one piece lower sub frame can be installed. Once the driver side of the front differential is tied up and out of the way, remove the hydraulic floor jacks from under the front differential.

Photo # 12

45. Locate the new one piece lower sub frame and the stock lower control arm mounting hardware that was removed from step # 26. On the driver side, install the front and rear part of the new one piece lower sub frame into the stock front and rear lower control arm mounting points using the stock hardware. **Do not tighten at this point and make sure to use thread locker or lock tite.** Repeat procedure on passenger side.

46. Carefully remove the tie down strap or the bungee cord that is holding the driver side of the stock front differential up and out of the way. Let the stock front differential rest on the newly installed one piece lower sub frame.

47. Locate the stock hardware that was removed from step # 28. Install the rear portion of the front differential into the tab on the rear portion of the new one piece lower sub frame. Secure using the stock hardware. **Do not tighten at this point and make sure to use thread locker or lock tite.**

Photo # 13

48. Locate the stock hardware that was removed from step # 35. Secure the newly installed front differential relocation bracket to the front portion of the new one piece lower sub frame. Secure using the stock hardware. **Do not tighten at this point and make sure to use thread locker or lock tite.**

Photo # 14

49. Place a hydraulic floor jack under the front portion of the new one piece lower sub frame. Carefully raise up on the hydraulic floor jack until the front portion of the sub frame seats flush with the stock front cross member. Using the holes in the front portion of the new one piece lower sub frame as a guide, carefully drill (2) 7/16" holes into the bottom of the stock front cross member. **Special note: On some vehicles, you may not have to drill the (2) 7/16" holes, they will already be in the stock front cross member.**

50. Locate (2) 7/16" x 1 1/2" bolts, (4) 3/8" USS flat washers and (2) 7/16" unitorque nuts from hardware 16985NB2. Secure the front portion of the new one piece sub frame to the stock front cross member using the new 7/16" x 1 1/2" bolt and hardware. Torque to **42 ft lbs.** **Make sure to use thread locker or lock tite.** Carefully remove the hydraulic floor jack from under the front portion of the newly installed one piece lower sub frame.

51. Working in this order, torque the following stock and new hardware to proper torque specifications. First, on the driver side of the vehicle, torque the stock hardware that connects the rear portion of the stock front differential into the rear pocket of the new one piece lower sub frame to **75 ft lbs.** Next, working on the driver side, torque the stock hardware that connects the new driver side differential relocation bracket to the front tabs located on the front portion of the new one piece lower sub frame to **75 ft lbs.** Next, working on the passenger side, torque the stock hardware that connects the new passenger side differential drop bracket to the stock location to **75 ft lbs.** Next, working on the passenger side, torque the new hardware that connects the stock front differential to the new passenger side differential drop bracket to **85 ft lbs.** Next, working on the driver side, torque the stock hardware that connects the new one piece lower sub frame to the stock front and rear lower control arm pockets to **105 ft lbs.** Finally, working on the passenger side, torque the stock hardware that connects the new one piece lower sub frame to the stock front and rear lower control arm pockets to **105 ft lbs.**

52. Reconnect the 4WD wiring to the front differential. Also, reconnect any other vent hoses and/or wiring that was connected to the stock front differential.

53. Locate (2) 6199 poly bump stops from hardware bag 16985PL. **Special note: There are (6) poly bump stops located in the poly bag, (4) are the same size and (2) are taller, locate (2) of the shorter poly bump stops.** Also, locate (2) 3/8" unitorque nuts and (2) 5/16" USS flat washers from hardware bag 16985NB1. Working on the driver side rear portion of the newly installed one piece lower sub frame, secure the new poly bump stop using the new 3/8" hardware. Torque to **28 ft lbs.** Repeat procedure on the passenger side. **Make sure to use thread locker or lock tite.**

54. Locate (2) 5/8" x 4 1/2" bolts, (2) 5/8" x 5 1/2" bolts, (8) 9/16" USS flat washers and (4) 5/8" unitorque nuts from hardware bag 16985NB5. Also, locate the stock lower control arms that were removed from step # 26. Working on the driver side, install the stock lower control arm into the newly installed one piece lower sub frame's front location and secure using the new 5/8" x 4 1/2" bolt and hardware. **Do not tighten at this point. Make sure to use thread locker or lock tite.** Install the stock lower control into the newly installed one piece lower sub frame's rear location and secure using the new 5/8" x 5 1/2" bolt and hardware. **Do not tighten at this point. Make sure to use thread locker or lock tite.** Repeat procedure on the passenger side.

55. Locate the new driver side steering knuckle and stock hub assembly, the stock hardware for the upper control arm ball joint and the lower control arm ball joint that was removed in step # 22. Using the stock hardware, secure the new driver side steering knuckle and stock hub assembly to the stock upper control arm ball joint and the stock lower control arm ball joint. **Special note: Do not install the stock outer tie rod to the new steering knuckle at this point.** Torque the stock upper ball joint hardware to **74 ft lbs.** and the stock lower ball joint hardware to **101 ft lbs.** **Special note: When installing the new driver side spindle, make sure that the stock brake line is located towards the inside of the vehicle. Make sure to use thread locker or lock tite.** Repeat procedure on the passenger side using the passenger side steering knuckle.

56. Locate the stock CV axles that were removed from step # 19. Working on the driver side, carefully install the stock CV axle back into the stock hub assembly. Repeat procedure on the passenger side.

57. Locate (12) 10 mm x 35 mm bolt and (12) 10 mm lock washers. Also, locate (2) 9802 CV axle shims. Working on the driver side, install (1) new CV axle shim between the stock front differential and the stock CV axle. Secure using the new 10 mm x 35 mm bolts and hardware. Torque to **45 ft. lbs. Make sure to use thread locker or lock tite. Special note: Make sure that the stock axle is re-installed back into the stock location on the stock front differential. Refer to the scribe mark that was made in step # 18.** Repeat on the passenger side.

58. Locate the stock hardware that connects the stock front axle to the stock hub assembly that was removed in step # 17. Also, locate the stock hub assembly caps that were removed in step # 16. Working on the driver side, secure the stock front axle to the hub assembly using the stock hardware. Torque to **154 ft. lbs. Make sure to use thread locker or lock tite. Re-install the stock hub assembly cap back into the stock location.** Repeat procedure on the passenger side.

59. Working on the driver side, reconnect the stock ABS lines back together. Also reconnect all other stock

mounting points on the stock ABS line. Repeat procedure on the passenger side.

60. Locate the stock rotors that were removed in step # 15. Working on the driver side, install the stock rotor into the stock location. Repeat procedure on the passenger side.

61. Locate the stock brake caliper hardware that was removed in step # 12. Working on the driver side, re-install the stock brake caliper to the new driver side spindle and secure using the stock hardware. Torque to **96 ft. lbs. Make sure to use thread locker or lock tite.** Repeat procedure on the passenger side.

62. Locate the stock brake line hardware that was removed in step # 12. Also, locate (10) shock ties. Working on the driver side, secure the stock brake line bracket to the stock upper control arm using the stock hardware. Next, shock tie the stock ABS line and the stock brake line to the newly installed spindle. Also, shock tie the stock ABS line and the stock brake lines together. Repeat procedure on the passenger side. **Special note: In this step make sure that once you shock tie the stock brake lines and ABS lines to the spindle, there will be no contact on the new wheels and tires. If contact occurs, the stock brake lines or ABS lines may be damaged.**

63. Locate the stock outer tie rod ball joint hardware that was removed from step # 11. Working on the driver side, install the stock outer tie rod to the new steering knuckle using the stock hardware. Make sure to use thread locker or lock tite and torque to **53 ft. lbs. Special note: The new steering knuckle has a reverse taper on it where the stock outer tie rod mounts to it, make sure to install the outer tie rod the proper way. The stock outer tie rod nut will now be installed on the bottom side of the new steering knuckle.**

64. Locate (2) new torsion bar cross member relocation brackets. Locate (4) PB4902 poly bushings from hardware bag 16985PL. Also, locate (2) S10074 sleeves from hardware bag 16985SL. Install the new poly bushings and sleeves into the new torsion bar cross member relocation brackets. **Special note: Make sure to use a lithium or moly base grease prior to inserting the new bushings and sleeves into the new torsion bar cross member relocation brackets. This will increase the life of the bushing as well as prevent squeaking.**

65. Working on the driver side, hold the new torsion bar cross member relocation bracket to the new location on the stock frame rail. **Special note: Using the larger cut out holes in the torsion bar cross member relocation bracket over the stock rivets on the bottom of the stock frame rail with help center the new torsion bar cross member relocation bracket.** With the new torsion bar cross member relocation bracket in place, use a pair

of vice grips and secure the new torsion bar drop bracket to the stock frame rail. Using the new torsion bar cross member relocation bracket as a guide, carefully drill (4) 7/16" holes into the stock frame, (2) on the side of the frame rail and (2) on the bottom. **Take special care not to drill into any stock hoses and/or lines running down the inside of the stock frame rail.** Remove the pair of vice grips that is holding the new torsion bar cross member relocation bracket to the frame rail. Repeat procedure on the passenger side of the vehicle.

66. Locate (8) 7/16" x 1 1/2" bolts, (16) 3/8" USS flat washers and (8) 7/16" unitorque nuts from hardware bag 16985NB2. Working on the driver side, secure the new driver side torsion bar cross member relocation bracket to the stock frame rail using the new 7/16" x 1 1/2" bolt and hardware. **Make sure to use thread locker or lock tite.** Torque to **76 ft lbs.** Repeat procedure on the passenger side.

Photo # 15

67. Locate the stock torsion bars that were removed from step # 9. Refer to the marks that were made in step # 7. This will allow you to re-install the stock torsion bars back into the stock location. **Example: Driver vs. Passenger and Front vs. Rear.** Working on the driver side, slide the stock torsion bar back into the stock rear lower control arm. Slide the stock torsion bar far enough forward so that the stock torsion bar cross member can be re-installed. Repeat procedure on the passenger side.

68. Locate the stock torsion bar cross member and stock hardware that was removed from step # 8. Install the stock torsion bar cross member to the newly installed torsion bar cross member relocation brackets and secure using the stock hardware. **Make sure to use thread locker or lock tite.** Torque to **90 ft lbs.**

69. Locate the stock torsion bar keys that were removed from step # 7. Working on the driver side, install the stock torsion bar key back into the stock location in the stock torsion bar cross member. Slide the stock torsion bar back into the previously installed torsion bar key. Repeat procedure on the passenger side.

70. Locate the torsion bar adjusting blocks and hardware that was removed from step # 6. Working on the driver side, attach the torsion bar removing tool to the stock torsion bar cross member, making sure that the unloading bolt in the center of the torsion bar removing tool is in the small divot of the stock torsion bar key. Adjust the torsion bar key up high enough so that the stock small metal adjusting block and bolt can be re-installed back into the stock location. Refer back to the measurements that were made in step # 5, and set to the torsion bar adjusting bolt to the stock setting. Repeat procedure on the passenger side. Carefully remove the torsion bar removing tool from the stock torsion bar cross member.

71. Locate the new front shocks. **Special note: New longer front shocks are needed, if you have not already ordered shocks, please contact Tuff Country or your local Tuff Country dealer and order the proper shocks. Tuff Country recommends using a 23" fully extended nitrogen gas shock.** Locate (2) S10073 from hardware bag 16985SL. Also, locate (4) PB8297 upper shock bushings and (4) S10107 upper shock washers from hardware bag 16985PL. Working on the new shocks, install the new lower shock bushing into the lower eyelet and install the new S10073 shock sleeves into the previously installed bushings. **Special note: Make sure to use a lithium or moly base grease prior to inserting the new lower shock bushings and sleeves into the new lower shock eyelet. This will increase the life of the bushing as well as prevent squeaking.** Working on the driver side, install the new shock into the stock location using the stock hardware on the bottom mount that was removed in step # 4 and the new hardware on the top mount. Repeat procedure on the passenger side. **Special note: Make sure to use the new upper bushings and upper shock washers.** Torque the lower shock mount to **65 ft lbs.** and the upper hardware to **22 ft lbs.** Repeat on passenger side. **Special note: Tuff Country EZ-Ride Suspension highly recommends that the shocks are installed with shock boots. If shock boots are not installed, damaged may occur to the piston of the new shock.**

72. Locate the stock front drive line and hardware that was removed from step # 3. Re-install the stock drive line back into the stock location and secure using the stock hardware.

73. Locate the stock skid plate that was removed in step # 3. Referring to photo # 18, measure 2 5/8" from the leading edge of the stock skid plate and scribe a mark. Carefully cut along the scribed mark.

**Photo # 16 / 2 5/8" measurement
Photo # 17 / post cut view**

74. Locate the (3) stock upper skid plate mounting hardware that we removed in step # 3. Install the newly modified skid upper skid plate to the stock upper location using the stock hardware. **Special note: Make sure to use thread locker or lock tite and torque to 28 ft lbs.**

75. Holding the stock skid plate to the front cross member, carefully drill a 3/16" hole through the stock skid plate and the stock front cross member.

Photo # 18

76. Locate (1) 1/4" x 1" self threading bolt from hardware bag 14985NB. Secure the stock skid plate to the stock cross member using the new 1/4" x 1" self threading bolt.

Photo # 19

77. Locate (2) front lateral compression arms. Locate (8) PB2408 poly bushings from hardware bag 16985PL. Also, locate (4) S10058 crush sleeves from hardware bag

16985SL. Install the new poly bushings into each end of the new front lateral compression arms. Next, install the new crush sleeve into the newly installed poly bushings. **Special note: Make sure to use a lithium or moly base grease prior to inserting the new bushings and sleeves into the new front lateral compression arms. This will increase the life of the bushing as well as prevent squeaking.**

78. Locate (2) 1/2" x 3 1/2" bolts, (4) 7/16" USS flat washers and (2) 1/2" unitorque nuts from hardware bag 16985NB3. Working on the driver side, secure (1) new lateral compression arm to the new front lateral compression arm mount on the newly installed one piece lower sub frame using the new 1/2" x 3 1/2" bolt and hardware. **Do not tighten at this point and make sure to use thread locker or lock tite.** Repeat procedure on the passenger side.

79. Working on the driver side, measure from the new lateral compression arm mount located on the previously installed one piece lower sub frame back to the center of the stock transfer case cross member. **Special note: Chevy has a variation on the placement of the stock transfer case cross member. Your measurement should either be 31" or 32" long. Remember the measurement, this measurement is needed in step # 80.**

80. Locate (2) 1/2" x 3 1/2" bolts, (4) 7/16" USS flat washers and (2) 1/2" unitorque nuts from hardware bag 16985NB3. Also, locate (2) rear lateral compression mounts. Working on the driver side, if the measurement that you had in step # 79 was 31", secure the new lateral compression arm to the new rear lateral compression arm mount rear hole using the new 1/2" x 3 1/2" bolt and hardware. **Do not tighten at this point.** If the measurement that you had in step # 75 was 32", secure the new lateral compression arm to the new rear lateral compression arm mount front hole using the new 1/2" x 3 1/2" bolt and hardware. **Do not tighten at this point.** Hold the new lateral compression arm and mount up to the stock transfer case cross member and scribe a mark on the transfer case cross member where the new mount will go. Repeat procedure on the passenger side.

81. Working on the driver side, carefully drill a 5/16" hole in the bottom of the stock transfer case cross member. Refer to the mark that was scribe in step # 80. Repeat procedure on the passenger side.

82. Working on the driver side lateral compression arm, remove the new lateral compression arm mount from the new lateral compression arm and save the new hardware for later re-installation. Repeat procedure on the passenger side.

83. Locate (2) 3/8" x 1 1/2" self threading bolts from hardware bag 16985NB1. Also, locate the new rear lateral compression arm mounts that were removed from

step # 82. Working on the driver side, secure the new rear lateral compression arm mount to the previously drilled hole in the stock transfer case cross member. Use the new 3/8" x 1 1/2" self threading bolt. Torque to **28 ft lbs.** Make sure to use thread locker or lock tite. Repeat procedure on the passenger side. **Special note: Make sure that the longer leg of the new lateral compression arm is towards the rear of the vehicle. Refer to Photo # 20 for proper placement.**

Photo # 20

84. Working on the driver side, secure the new lateral compression arm to the previously installed rear lateral compression arm mount. Secure using the new 1/2" x 3 1/2" bolt and hardware. Torque the front and rear mount to **85 ft lbs.** Repeat procedure on the passenger side

Photo # 21 / Front Location

Photo # 22 / Rear Location

85. Re-install the tires and wheels and carefully lower the vehicle to the ground.

86. There is still a couple of steps that need to be completed on the front end but these steps will not be completed until the rear end installation is completed and the weight of the vehicle is on the ground. These steps include; the installation of the front sway bar end links and the tightening of the new hardware that connects the lower control arms to the newly installed sub frame.

Rear end installation:

87. To begin installation, block the front tires of the vehicle so that the vehicle is stable and can't roll forward. Safely lift the rear of the vehicle and support the frame with a pair of jack stands. Place a jack stand on both the driver and passenger side. Next, remove the wheels and tires from both sides.

88. Working on the driver side, remove the stock shock from the stock upper and lower mounting points and save the stock hardware for later re-installation. The stock shocks may be discarded. **Special note: New longer rear shocks are needed, if you have not already ordered shocks, please contact Tuff Country or your local Tuff Country dealer and order the proper shocks. Tuff Country recommends using a 30" fully extended nitrogen gas shock.** Repeat procedure on the passenger side.

89. Place a pair of hydraulic floor jacks under the rear differential and carefully raise up on both hydraulic floor jacks at the same time until they come into contact with the rear differential.

90. Working on the driver side, remove the stock u-bolts from the stock location and discard the stock u-bolts and hardware. Set the stock upper and lower u-bolt plates a side for later re-installation. Repeat procedure on passenger side.

91. Carefully lower down both hydraulic floor jacks at the same time approximately 5". **Special note: Take special care not to over extend any brake lines and/or hoses.**

92. Locate (2) new rear 4" lifted blocks. Working on the driver side, install the new 4" lifted block into the stock location. Repeat procedure on the passenger side.

93. Carefully raise up on both hydraulic floor jacks at the same time until the stock spring assembly sits flush with the newly installed 4" lifted block.

94. Locate (4) 5/8" x 2 3/4" x 14" square u-bolts. Locate (8) 5/8" u-bolt high nuts and (8) u-bolt washers from hardware bag 58NW. Also, locate the stock upper and lower u-bolt plates that were removed from step # 90. Working on the driver side, install the new u-bolts into the stock location and secure using the new 5/8" high nuts and washers. **Special note: Make sure to re-install the stock upper and lower u-bolt plates.** Torque to **135 ft lbs.** Repeat procedure on passenger side.

95. Working on the driver side. **Special note: New longer rear shocks are needed, if you have not already ordered shocks, please contact Tuff Country or your local Tuff Country dealer and order the proper shocks. Tuff Country recommends using a 30" fully extended nitrogen gas shock.** Locate (2) S10074 from hardware bag 16985SL. Working on the new shocks, install the new shock bushing into the upper and lower eyelets of the new shocks. Next, install the new shock sleeves into the previously installed shock bushings. **Special note: Use the new S10074 shock sleeves and the proper shock sleeves that are located in the new sleeve bag that was provide with your new shocks. Make sure to use a lithium or moly base grease prior to inserting the new lower shock bushings and sleeves into the new lower shock eyelet. This will increase the life of the bushing as well as prevent squeaking.** Working on the driver side, install the new shock into the stock location and secure using the stock hardware that was removed in step # 88. **Special note: Make sure to use thread locker or lock tite and torque to 75 ft lbs.** Repeat procedure on the passenger side. **Special note: Tuff Country EZ-Ride Suspension highly recommends that the shocks are installed with shock boots. If shock boots are not installed, damaged my occur to the piston of the new shock.**

Photo # 23 / complete installation of the new blocks, u-bolts and shocks.

96. Carefully remove the (2) hydraulic floor jacks from under the rear differential.

97. Locate (2) 6199 poly bump stops and (2) 6052 poly bump stops from hardware bag 16985PL. Also, locate (4) 3/8" unitorque nuts and (4) 5/16" USS flat washers from hardware bag 16985NB1. Working on the driver side of the stock rear spring assembly. Remove the (2) stock

teflon inserts located on the stock over load in the stock spring assembly. Discard the stock teflon inserts. Install (1) 6052 (taller poly bump stop) in front location on the stock spring assembly. Secure using the new 3/8" hardware. Torque to **28 ft lbs.** Install (1) 6199 (shorter poly bump stop) in the rear location on the stock spring assembly. Secure using the new 3/8" hardware. Torque to **28 ft lbs.** Repeat procedure on the passenger side.

Illustration # 24 / front location

Illustration # 25 / rear location

If the vehicle that you are working on has a 2 piece rear drive shaft, please follow step 98 — 99

If the vehicle that you are working on does not have a 2 piece rear drive shaft, please skip to step # 100

98. Carefully place a hydraulic floor jack under the rear driveline near the stock carrier bearing mounting location. Raise up on the hydraulic floor jack until it comes into contact with the rear driveline. Remove the stock hardware that connects the stock carrier bearing to the stock location and discard the stock hardware. Carefully lower down on the hydraulic floor jack allowing enough room for the new rear carrier bearing drop bracket to be installed.

99. Locate the new rear carrier bearing drop. Locate (2) S10007 crush sleeves from hardware bag 16985SL. Also, locate (2) 3/8" x 3 1/2" bolts, (4) 5/16" USS flat washers and (2) 3/8" unitorque nuts from hardware bag 16985NB1. Install the new carrier bearing drop bracket between the stock carrier bearing and the stock mounting point. Secure using the new 3/8" x 3 1/2" bolts, crush sleeves and hardware. Torque to **28 ft lbs.** Carefully remove the hydraulic floor jack from under the rear drive line. **Special note: The stock carrier bearing mount has slotted holes, make sure that when you torque the new 3/8" hardware that the new carrier bearing is pushed as far forward as possible.**

Illustration # 26

100. Install the tires and wheels and carefully lower the vehicle to the ground.

Step # 101 and # 102 needs to be performed with the weight of the vehicle on the ground.

101. Working on the driver side, move back to the new 5/8" hardware attaching the stock lower control arms to the newly installed one piece lower sub frame and torque to **125 ft lbs.** Repeat procedure on the passenger side.

102. Locate (2) 3/8" x 7" bolts and (2) 3/8" unitorque nuts from hardware bag 16985NB1. Locate (2) S10067 sway bar end link sleeves from hardware bag 16985SL. Also, locate (8) sway bar end link poly bushings and (8) sway bar end link washers from hardware bag 16985PL. **Special note: If you did not invert the stock sway bar in step # 10, invert the stock sway bar now.** Working

on the driver side, install the new sway bar end link and hardware into the stock location and torque to **32 ft lbs.** Repeat procedure on passenger side.

103. Check and double check to make sure that all steps were performed properly and then check again. Check and make sure that all new and stock hardware has been torqued to proper torque specification. Refer to the torque specification at the end of the installation manual.

104. Take the vehicle directly to an alignment shop for a proper front end alignment.

If you have any questions regarding the installation, please contact the technical department @ Tuff Country. (801) 280-2777

Special note: After the vehicle has been aligned, in 2WD, test drive the vehicle to check for any drive line vibrations. If drive live vibrations occur, the stock drive line may need to be rebalanced. If the stock drive line is rebalanced and vibration still occurs, please follow steps 105 — 106

105. Place a pair of hydraulic floor jacks under the stock transfer case cross member. Carefully raise up on both hydraulic floor jacks at the same time until the hydraulic floor jacks come into contact with the stock transfer case cross member. Working on the driver side, remove the (2) stock bolts and hardware that connects the stock transfer case cross member to the bottom sides of the stock frame rail. On the side of the stock frame rail, remove and discard the stock transfer case support bracket and hardware. Repeat procedure on the passenger side.

106. Carefully lower down on both hydraulic floor jacks at the same time about 3/4". Locate (8) 2" x 2" square washers. Also, locate (4) 1/2" x 2" bolts, (8) 7/16" USS flat washers and (4) 1/2" unitorque nuts from hardware bag 16985NB3. Working on the driver side, install (4) shims, (2) in the forward hole and (2) in the rearward hole, between the stock transfer case cross member and the stock frame rail. Secure using the new 1/2" x 2" bolt and hardware. Torque to **85 ft lbs.** Repeat procedure on the passenger side. Remove both hydraulic floor jacks.

Congratulations, installation complete. Check and double check to make sure that all steps were performed properly. Check torque settings to make sure that all stock and new hardware has been torqued to proper torque specifications

Also refer to the Vehicle owners manual for proper torque specifications on any stock hardware.

If you have any questions and/or concerns about the installation, please feel free to contact Tuff Country or your local Tuff Country dealer.

Torque settings:

5/16"	15 - 18 ft lbs.
3/8"	28 - 32 ft lbs.
7/16"	30 - 35 ft lbs.
1/2"	65 - 85 ft lbs.
9/16"	85 - 120 ft lbs.
5/8"	95 - 130 ft lbs.
3/4"	100 - 140 ft lbs.

Also refer to the Vehicle owners manual for proper torque specifications on any stock hardware.

Special post installation procedure: Tuff Country EZ-Ride Suspension highly recommends adding a minimum of 1 pint, but no more that 1 1/2 pints, of proper front differential fluid into the front differential. To achieve this, you may have to fill the differential with it on its side or you may have to insert the fluid through the vend tube opening. On occasion, the customer may find burping of fluid coming out of the front vent tube.

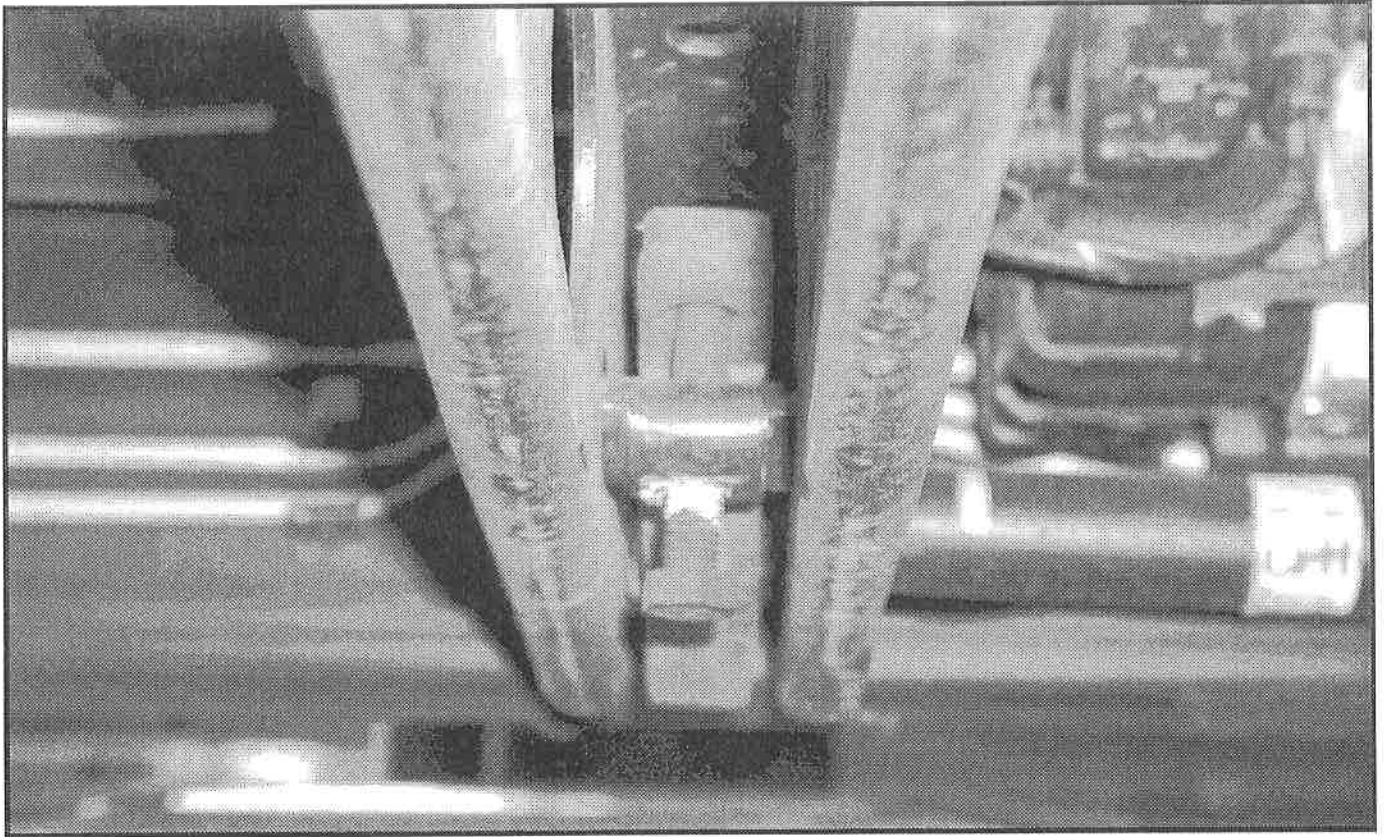

Photo # 1

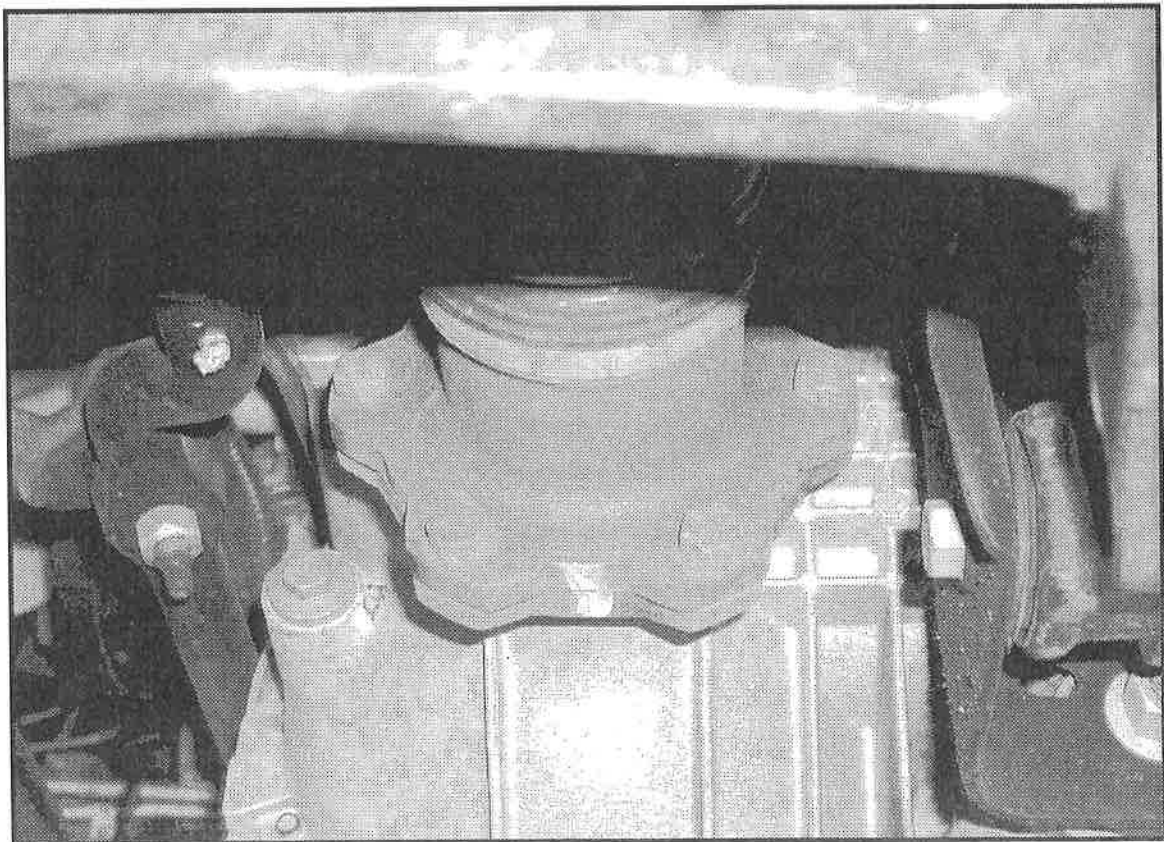

Photo # 2

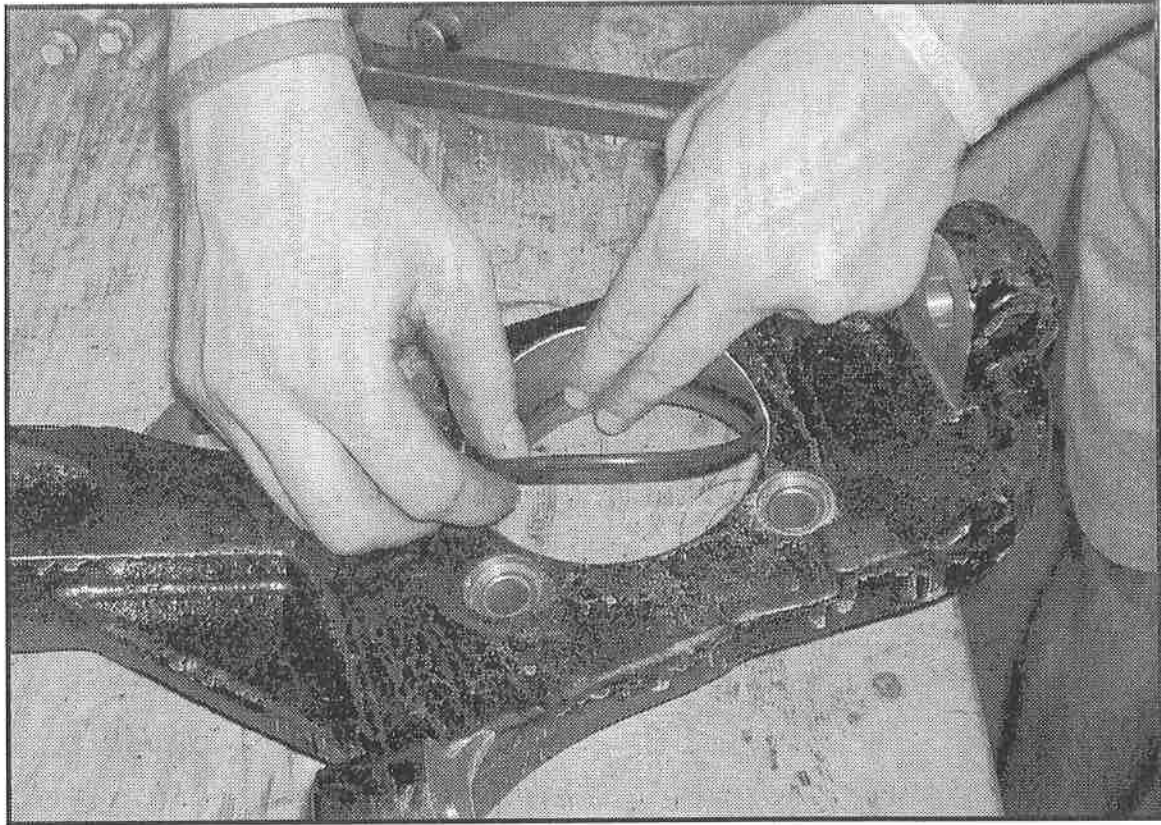

Photo # 3

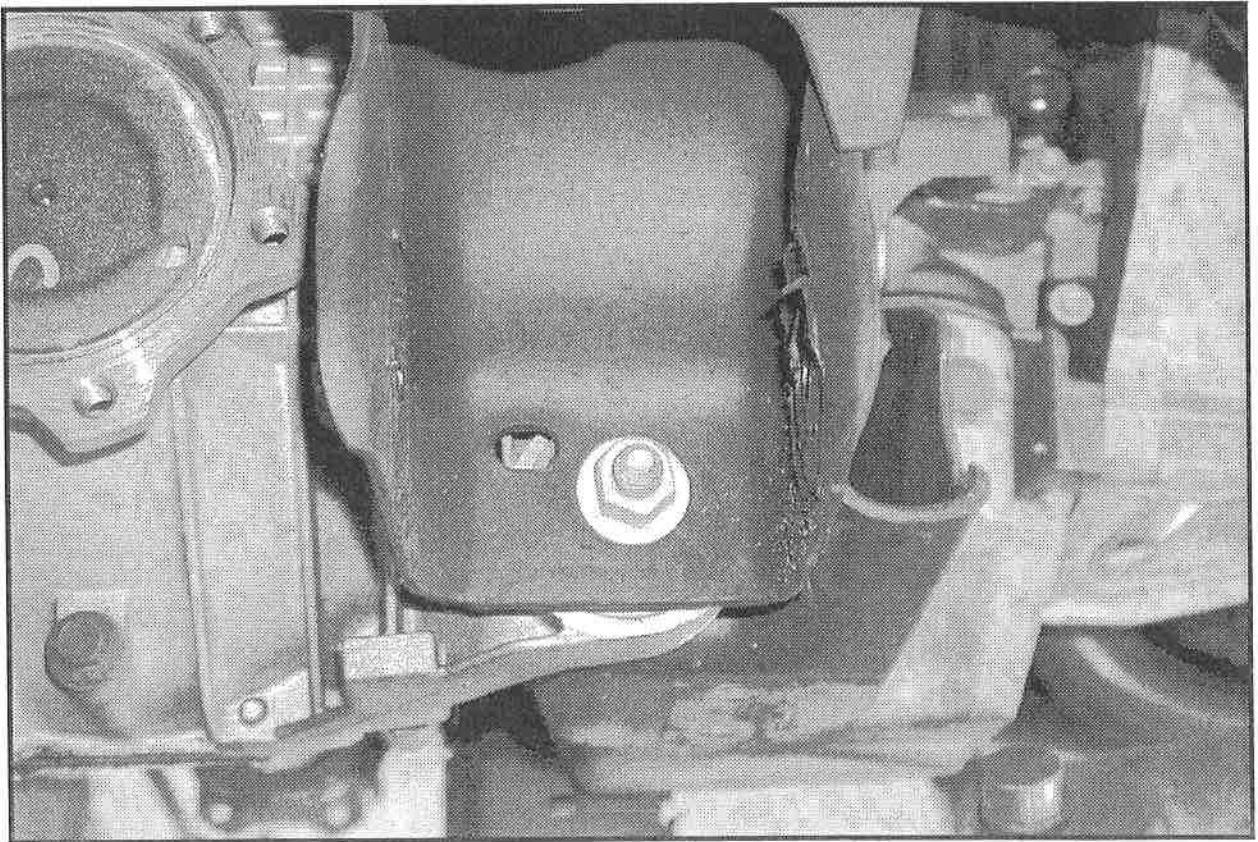

Photo # 4

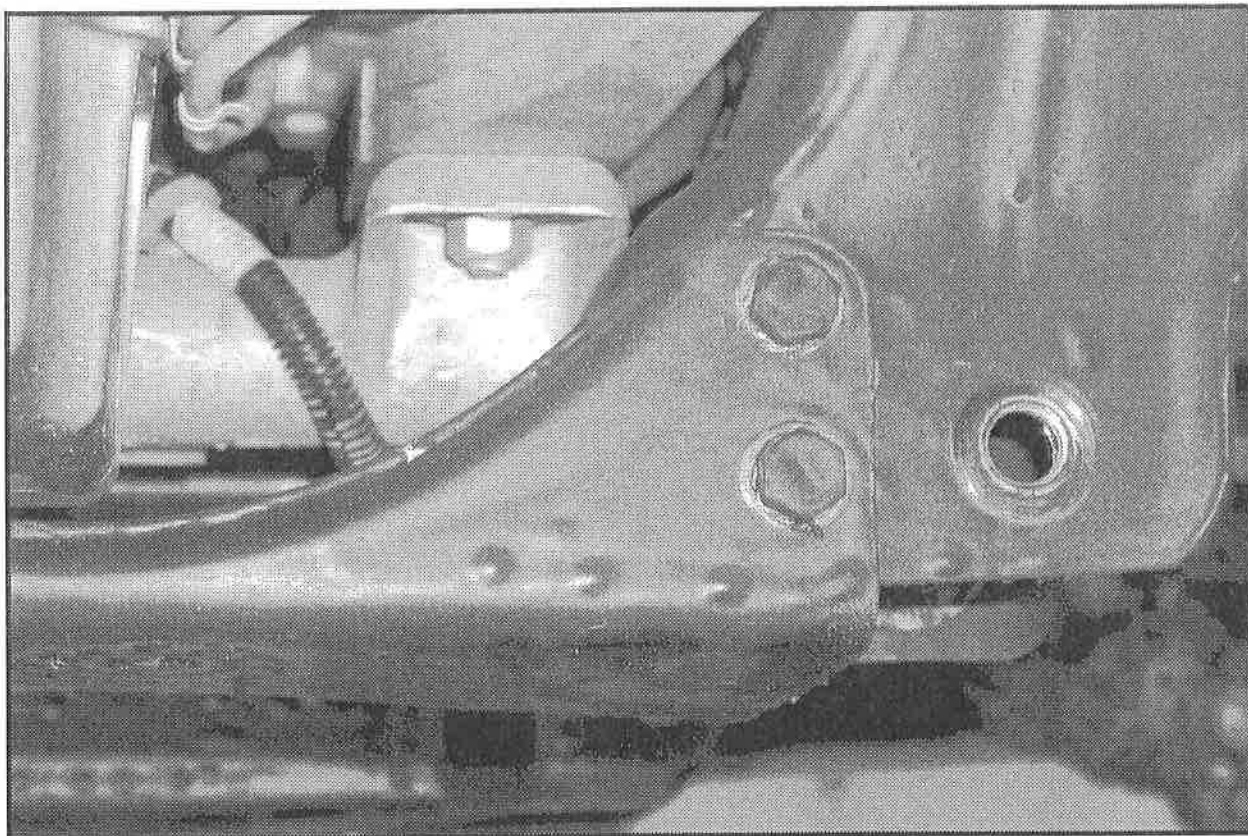

Photo # 5

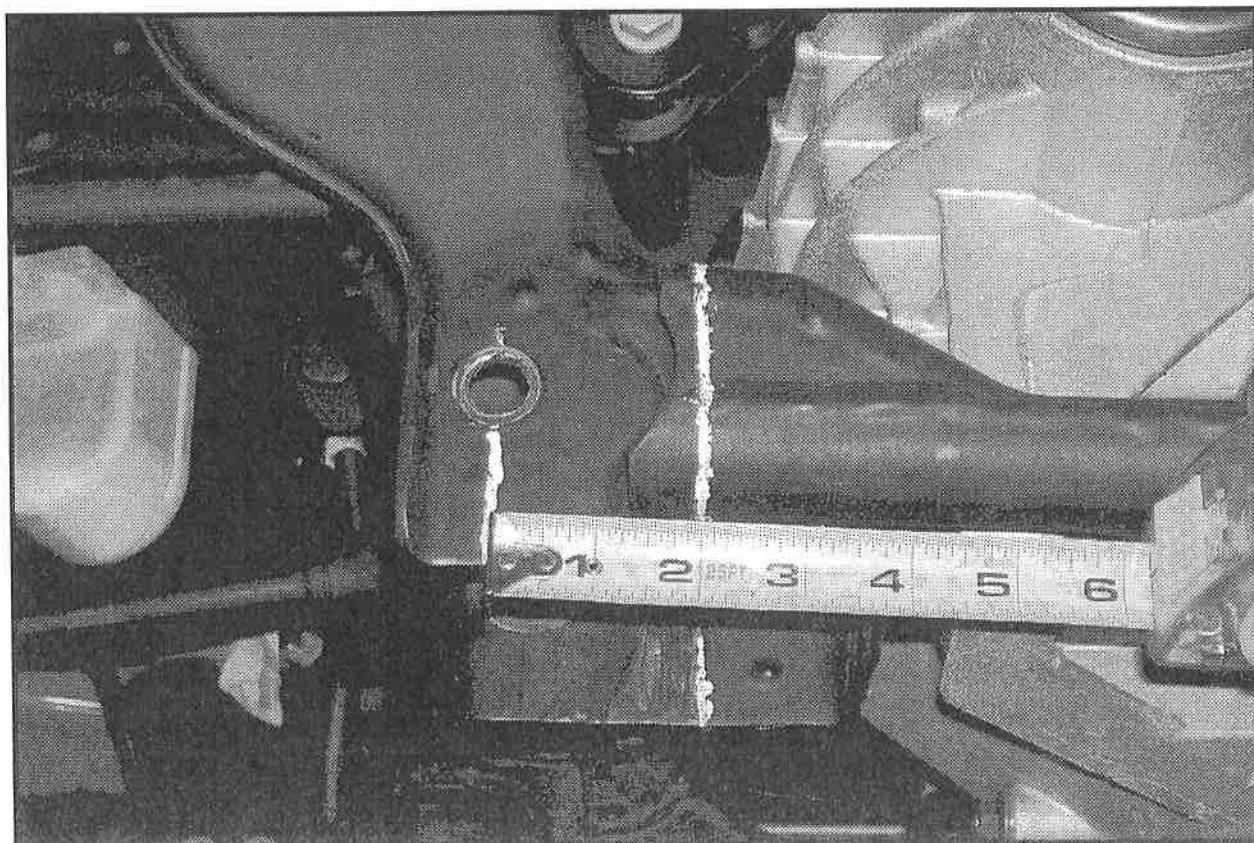

Photo # 6

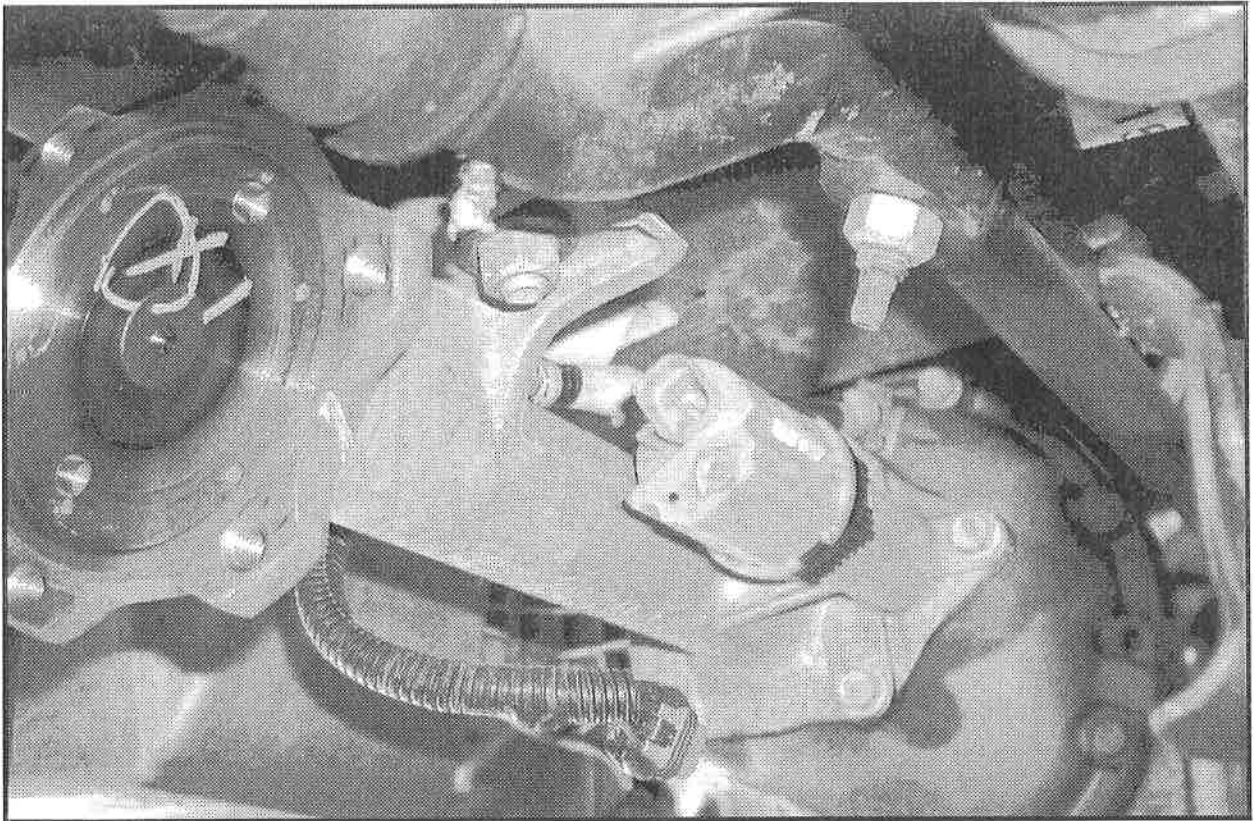

Photo # 7

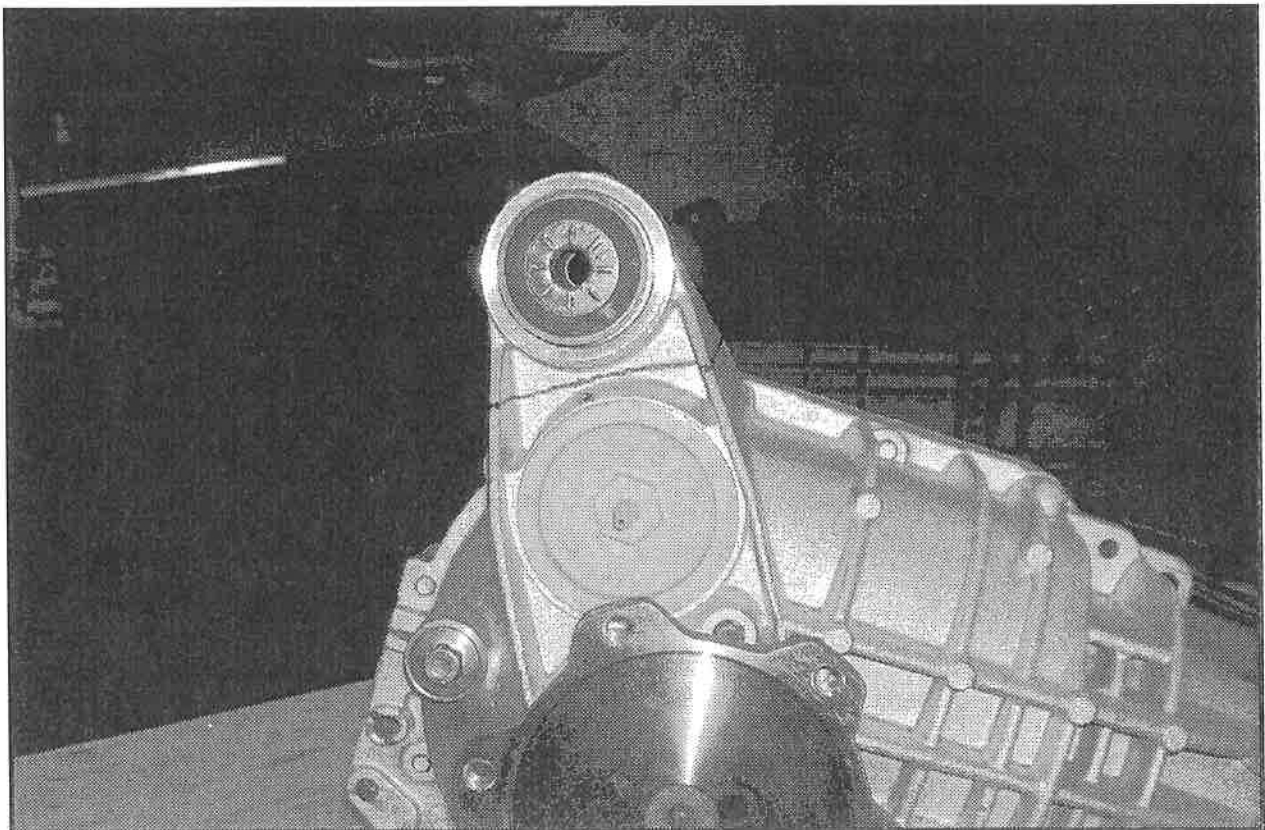

Photo # 8

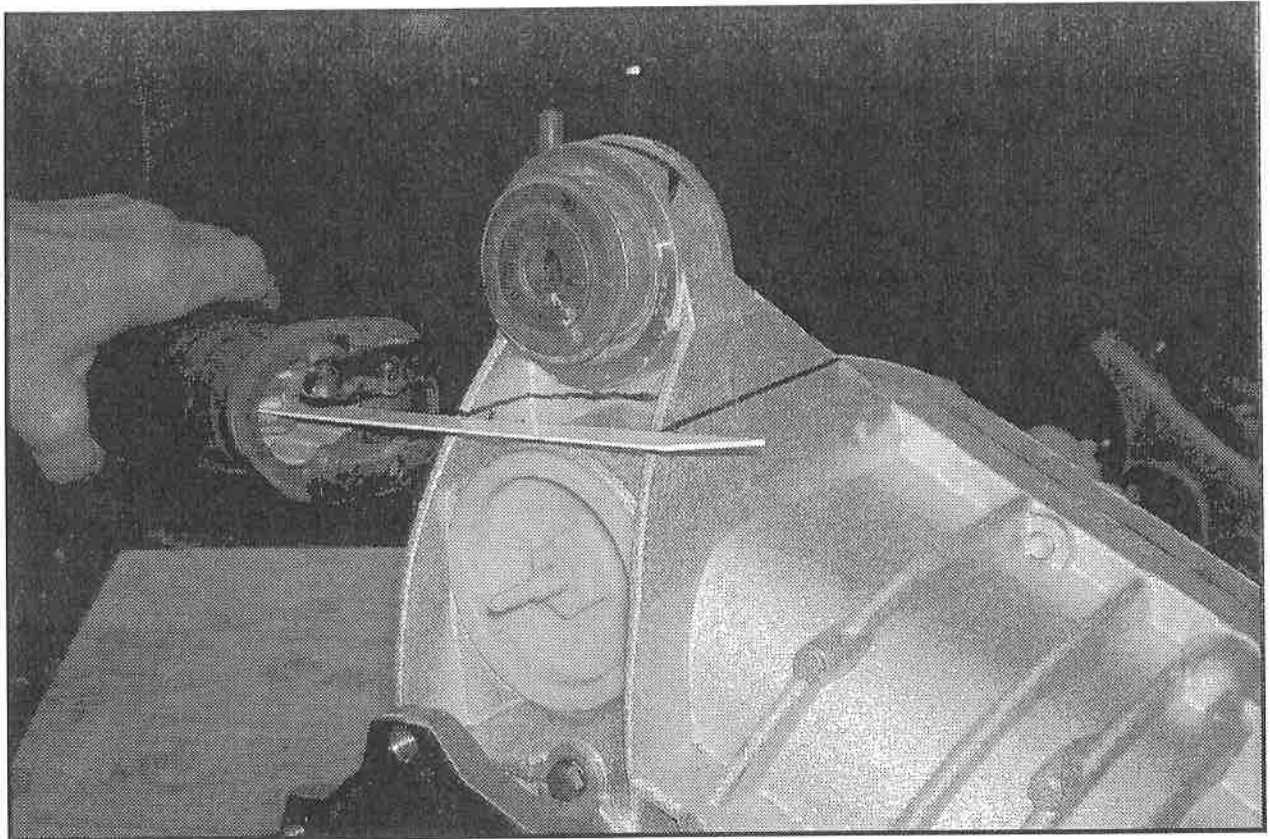

Photo # 9

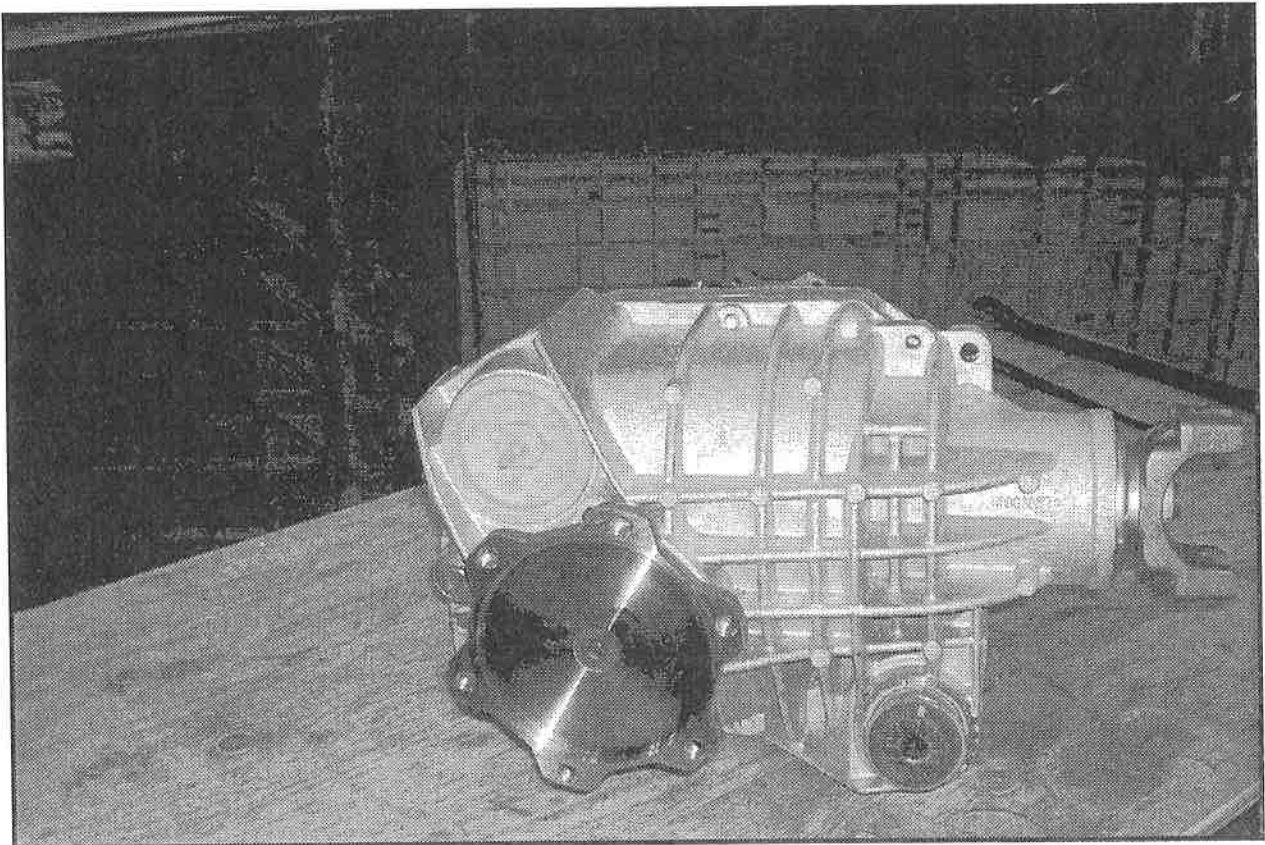

Photo # 10

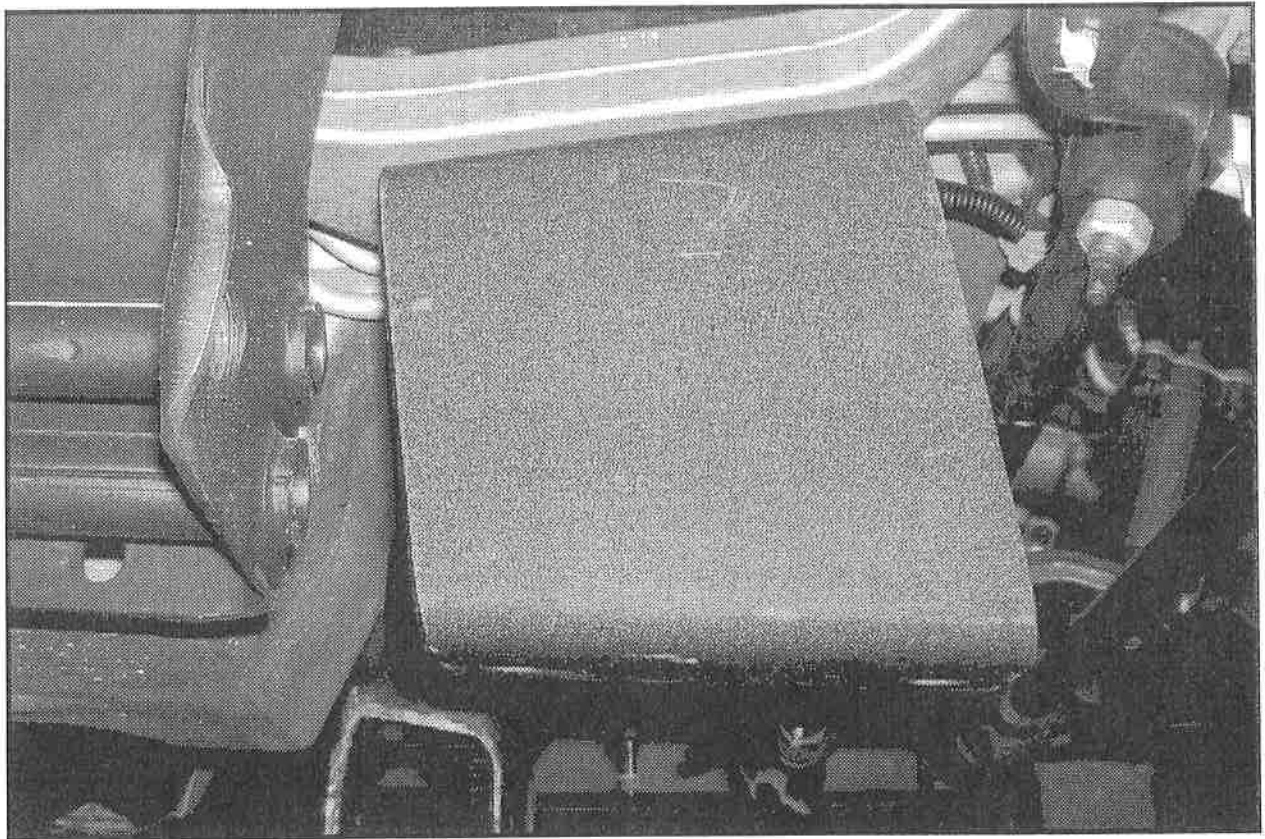

Photo # 11

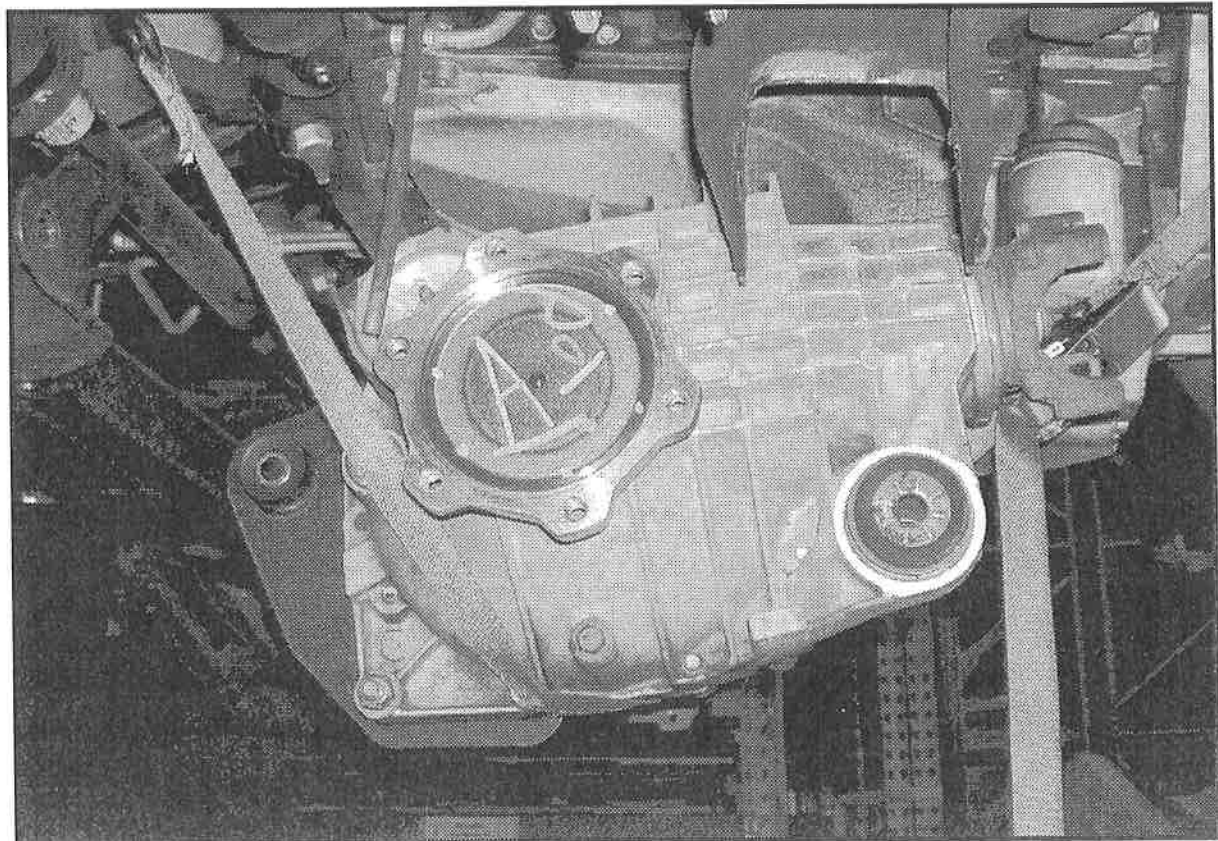

Photo # 12



Photo # 13

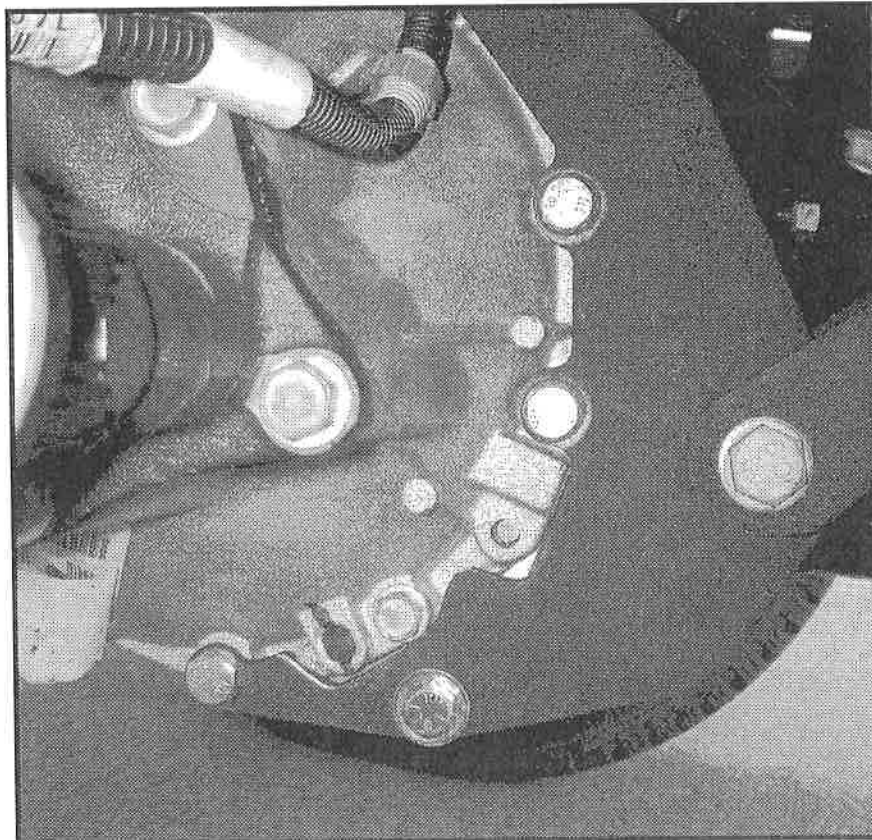

Photo # 14



Photo # 15

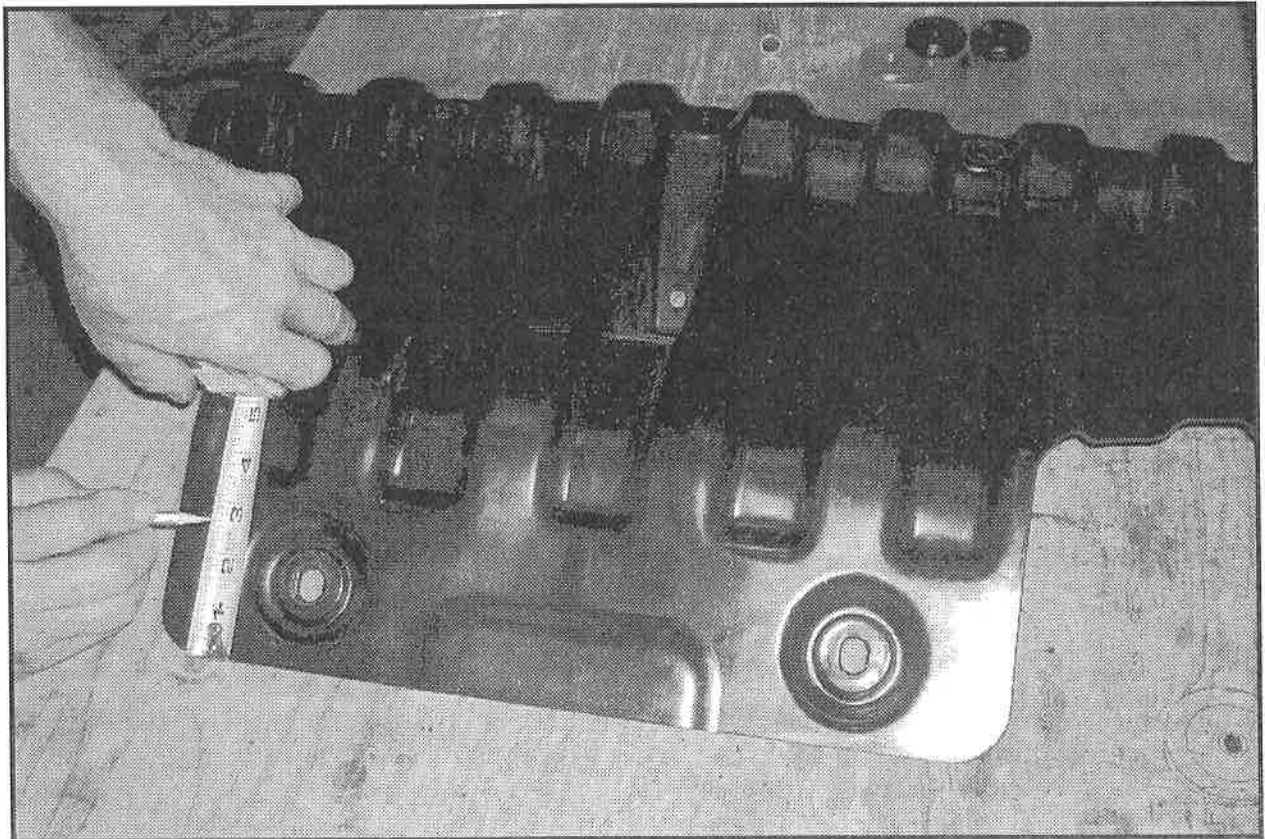

Photo # 16

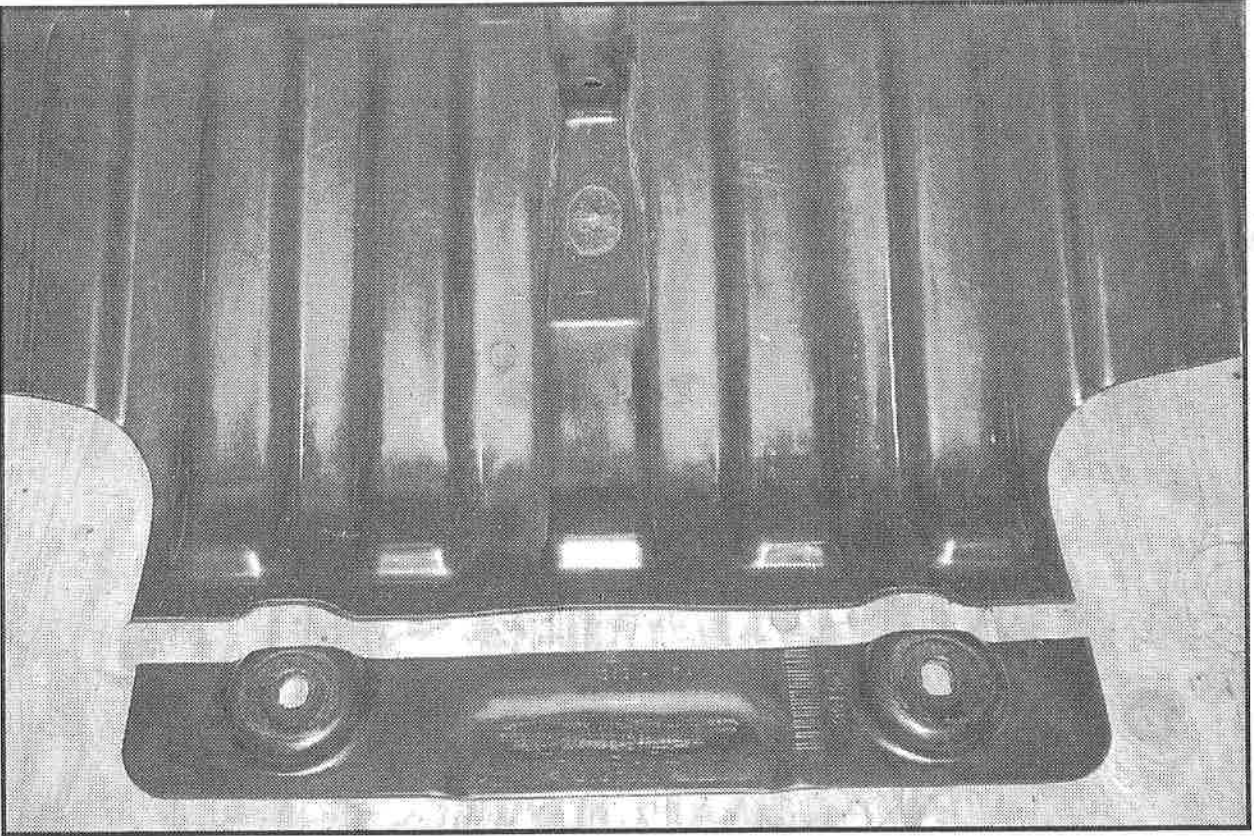

Photo # 17

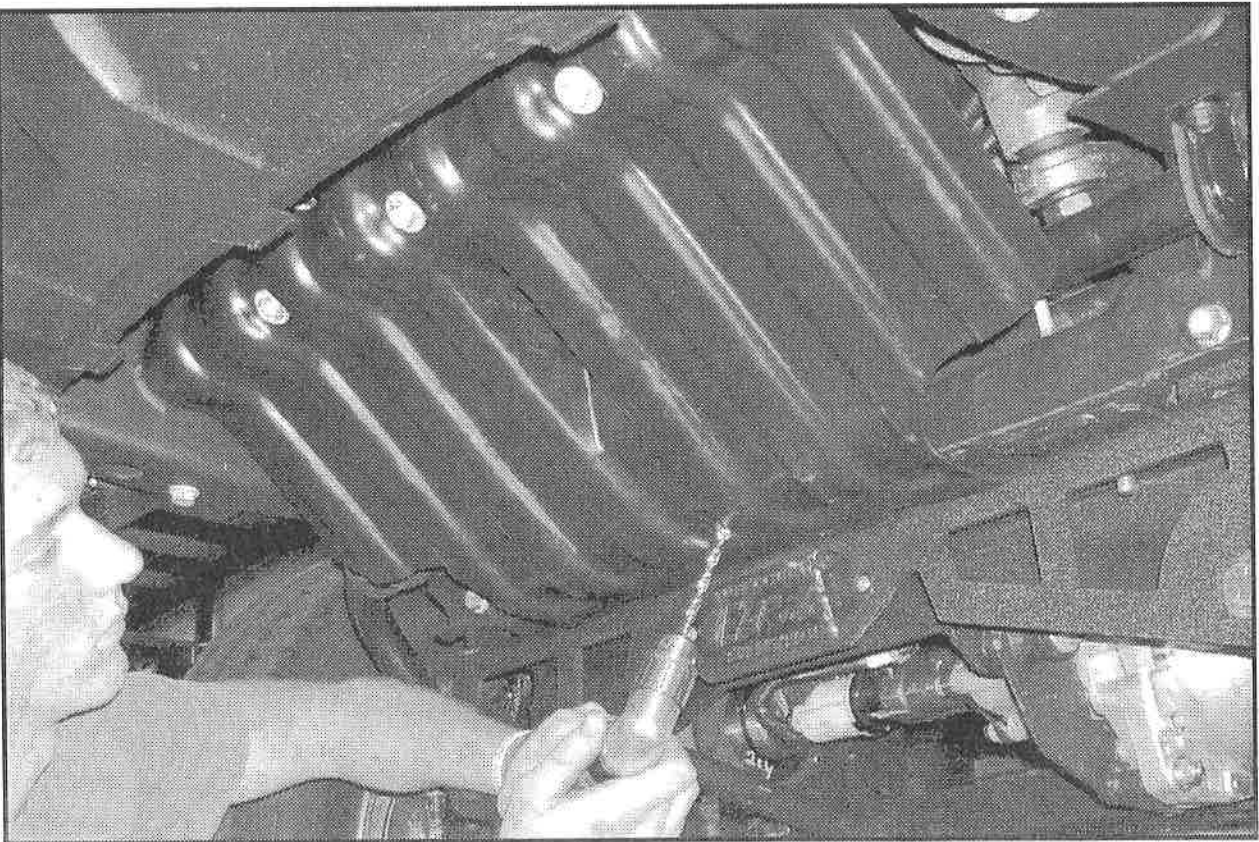

Photo # 18



Photo # 19

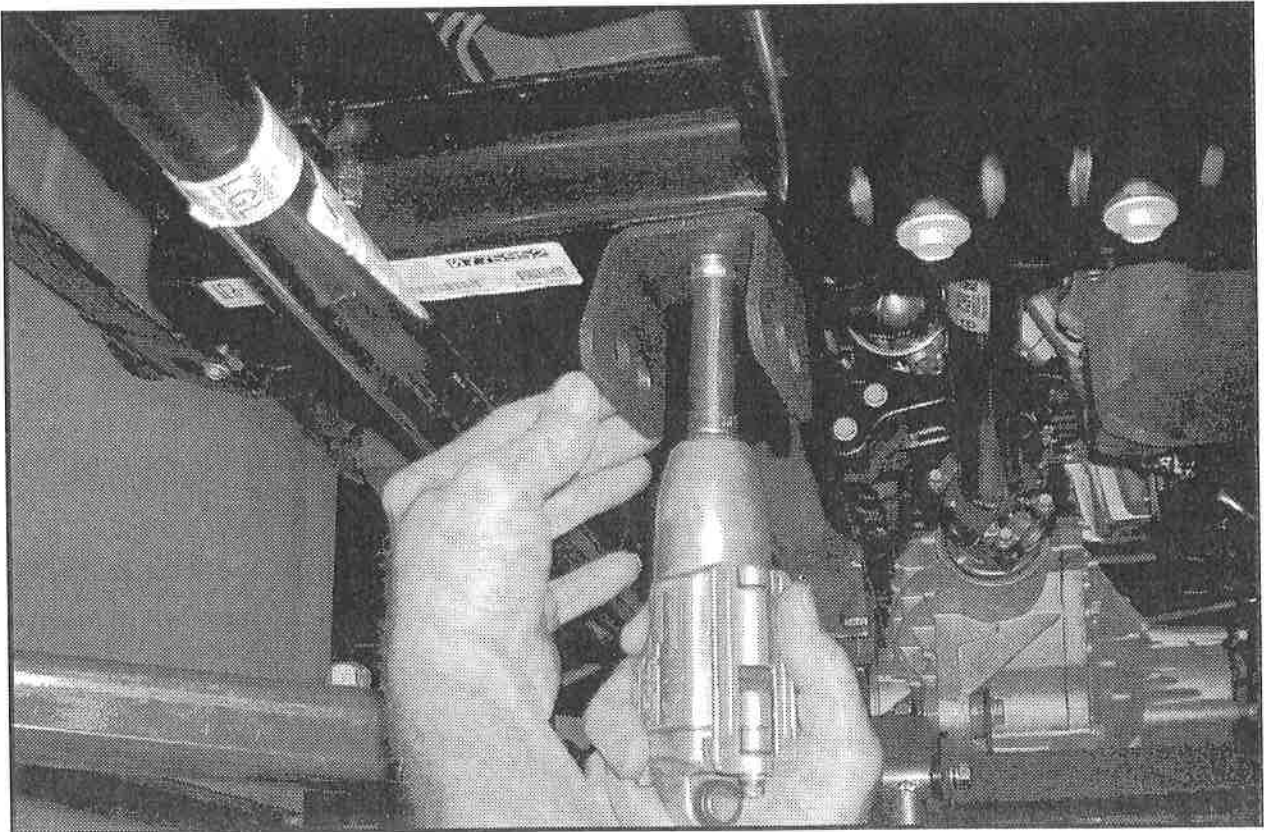

Photo # 20

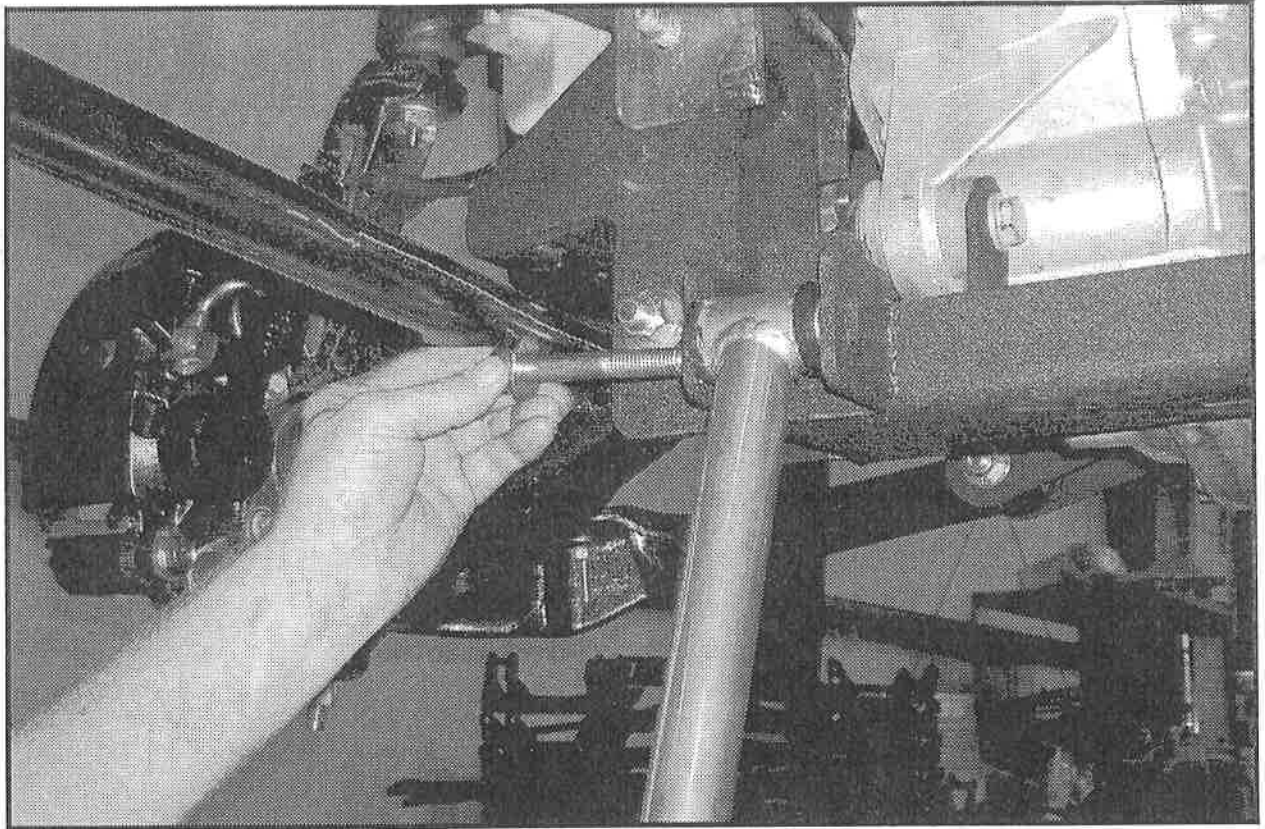

Photo # 21

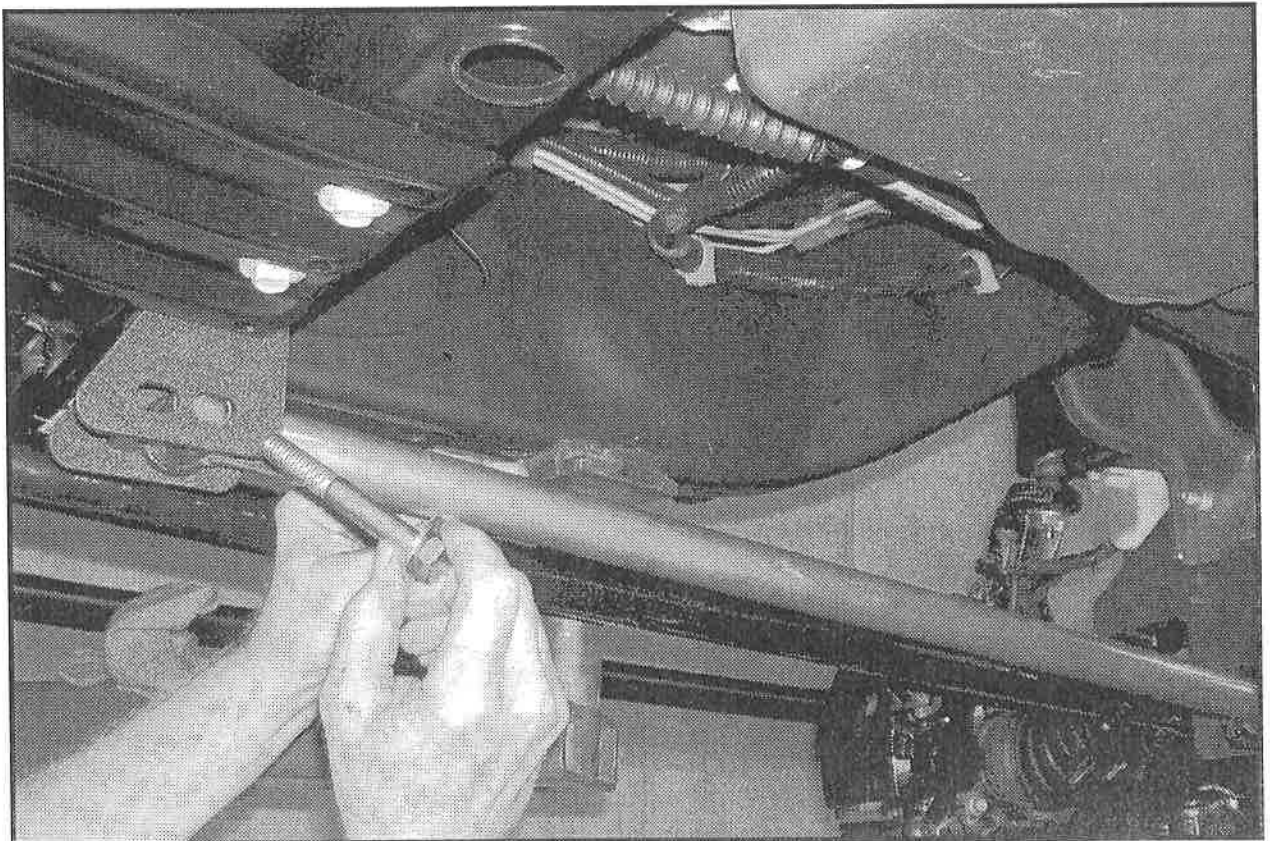

Photo # 22

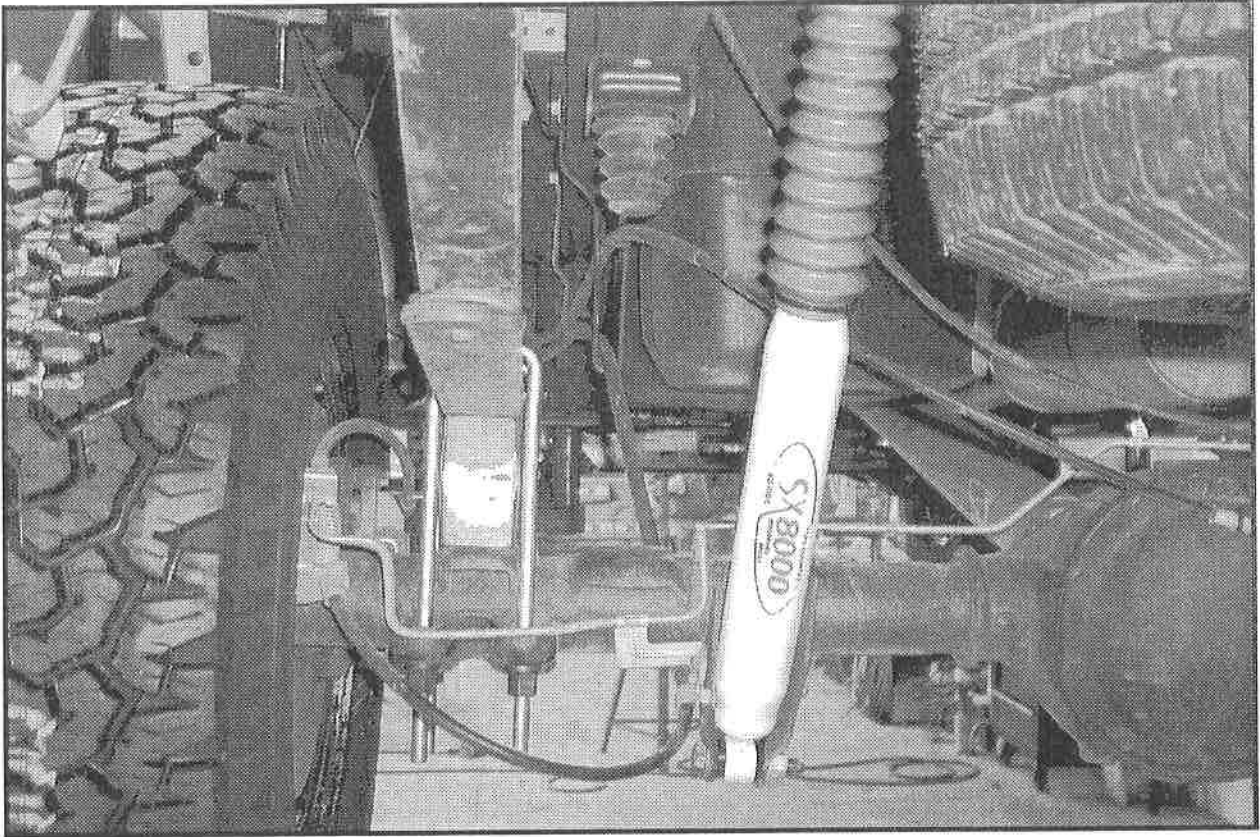

Photo # 23

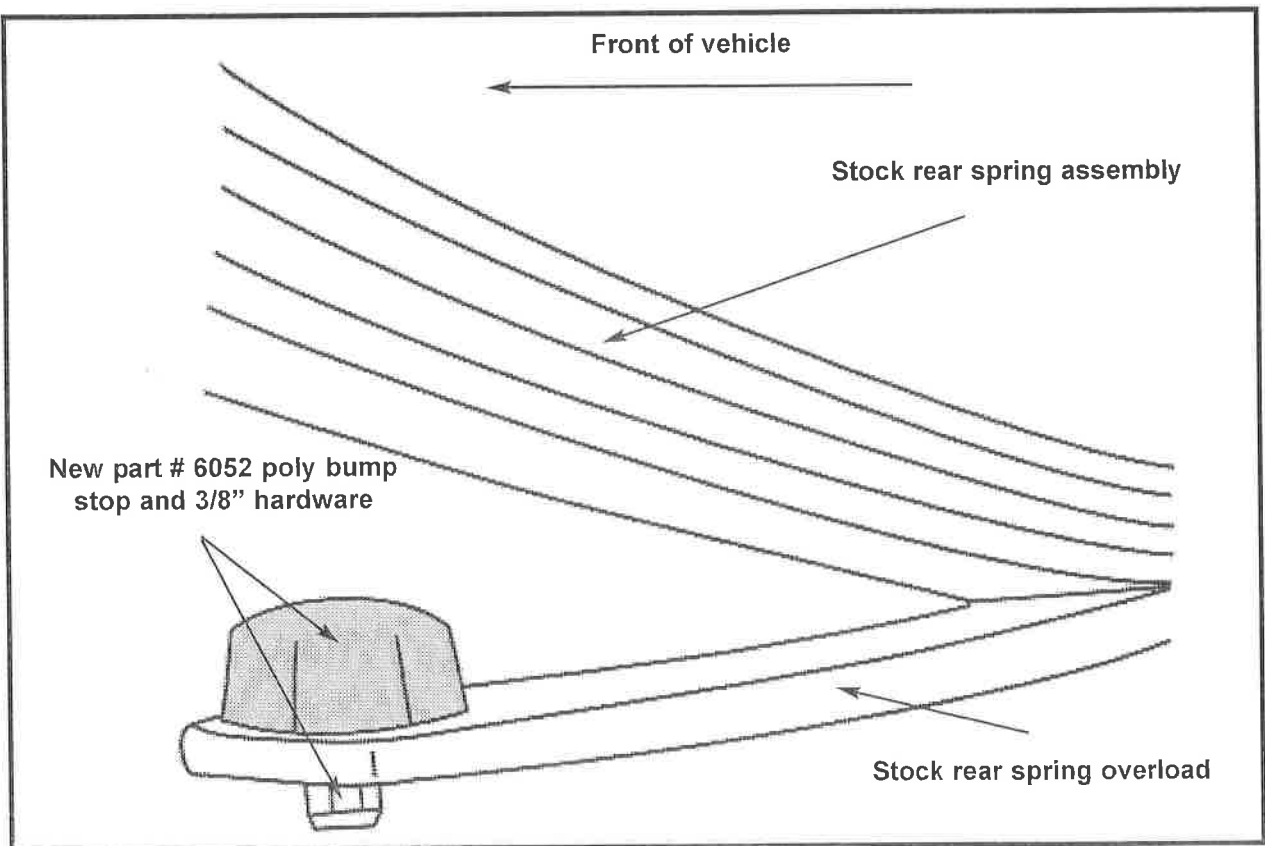

Illustration # 24

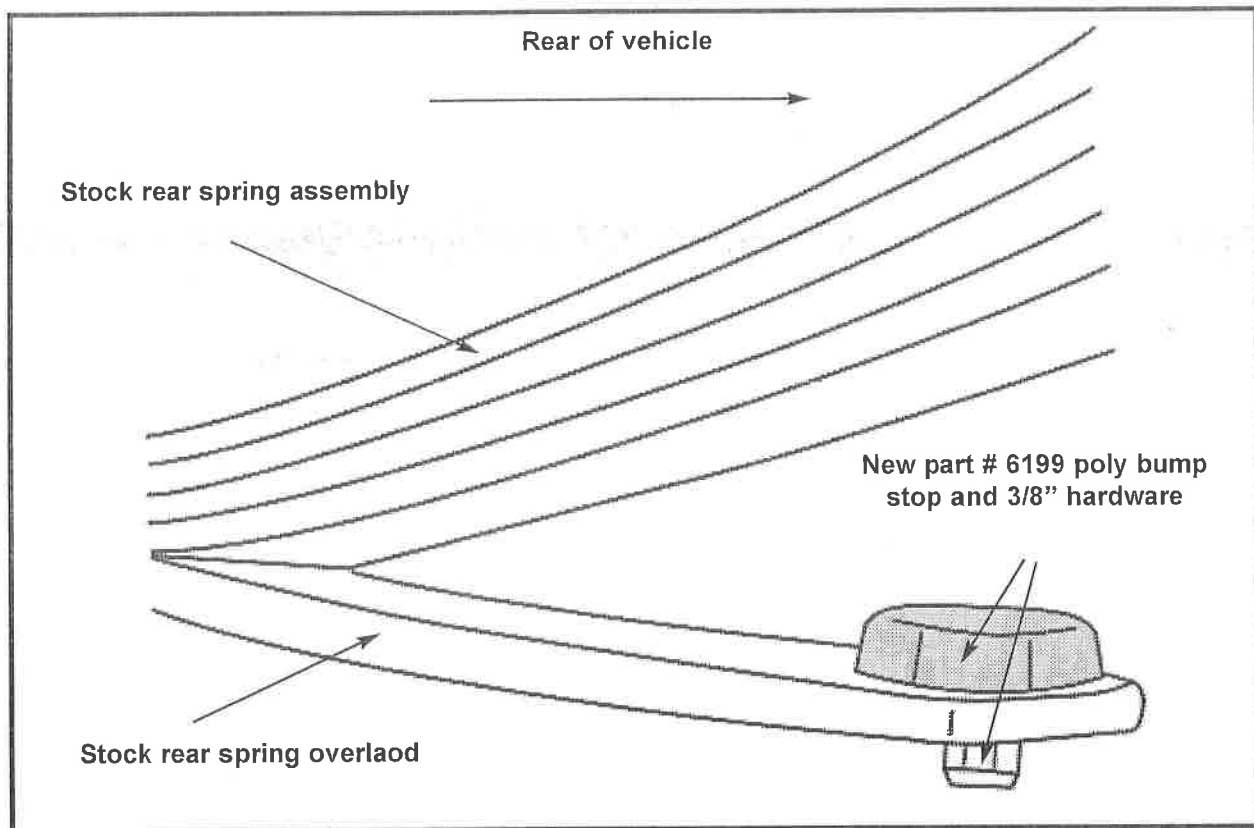

Illustration # 25

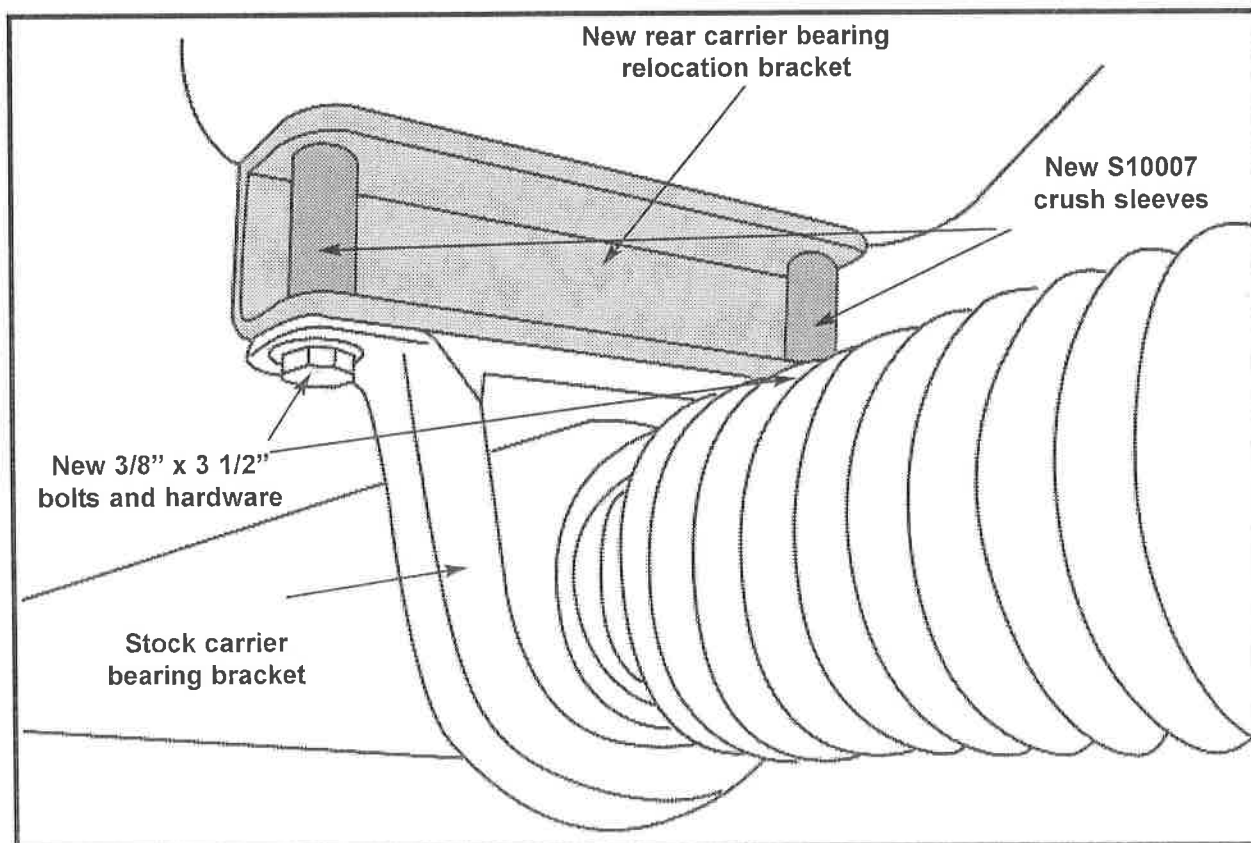
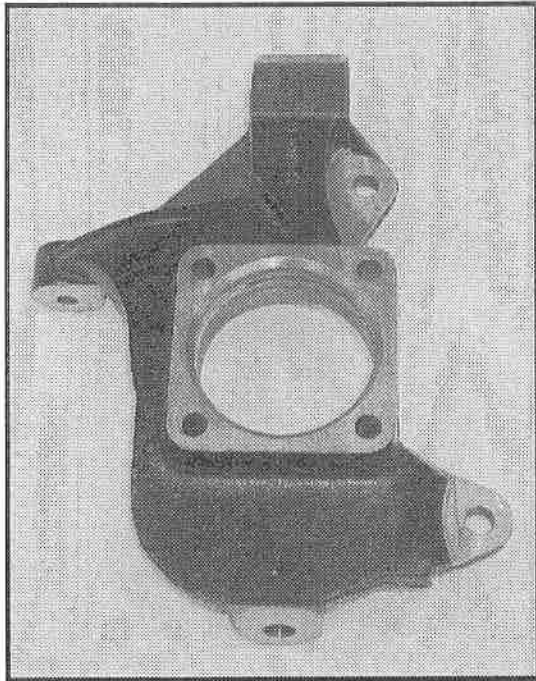
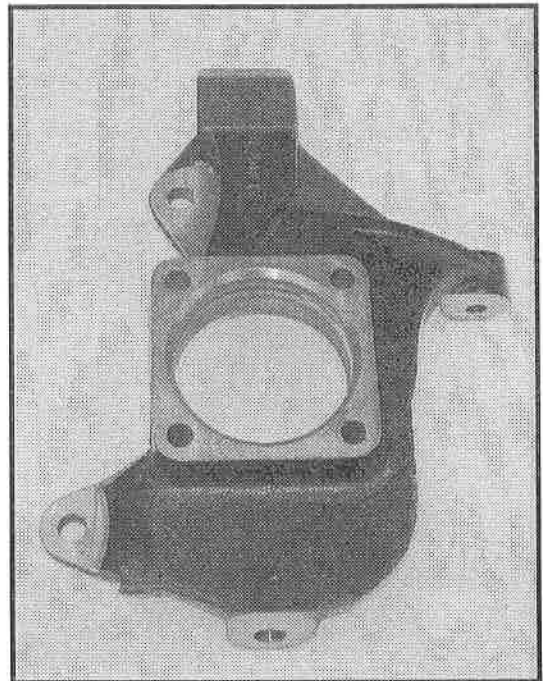

Illustration # 26



16985-01M / qty. 1



16985-02M / qty. 1

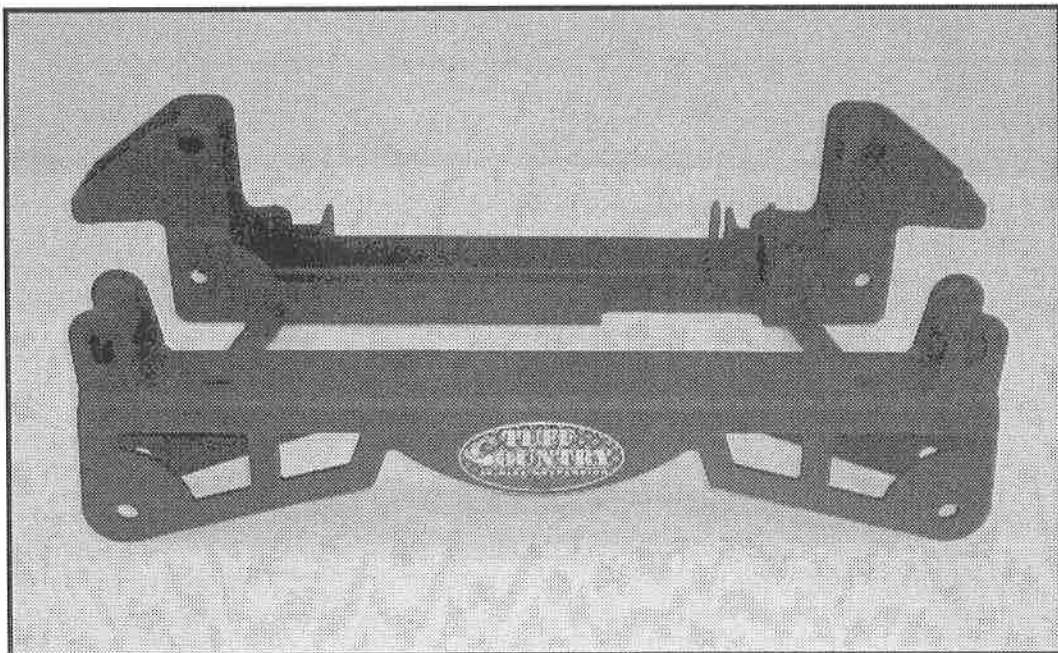

16985-04 / qty. 1

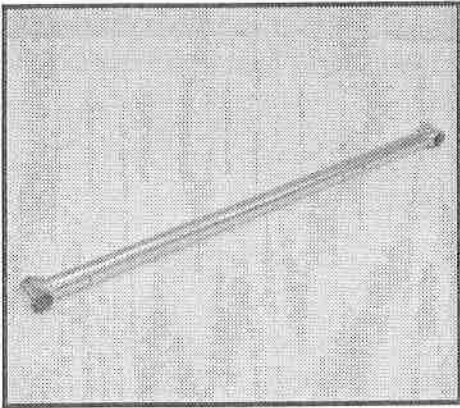

16985-12 / qty. 2

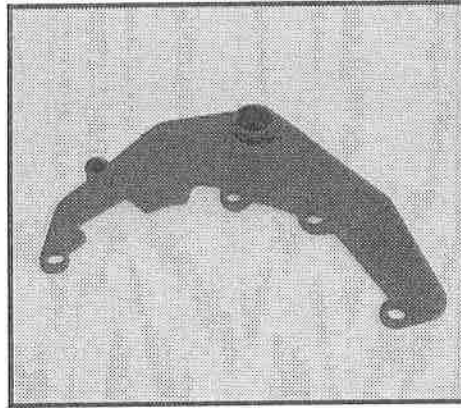

HDDIFF-01 / qty. 1

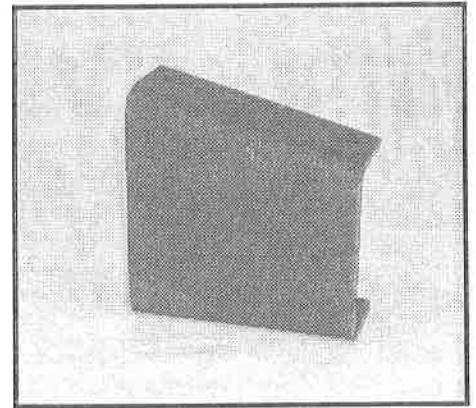

16985-07 / qty. 1

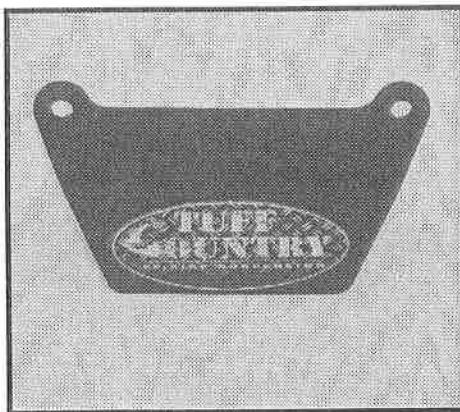

16958-16 / qty. 2

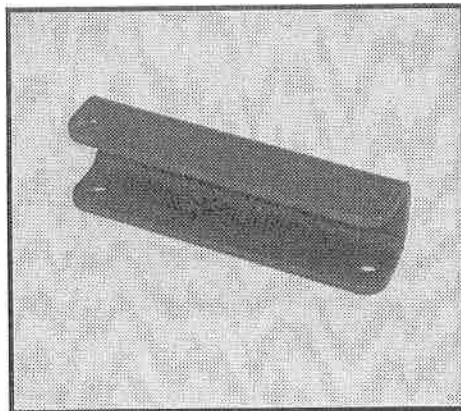

16985-10 / qty. 1

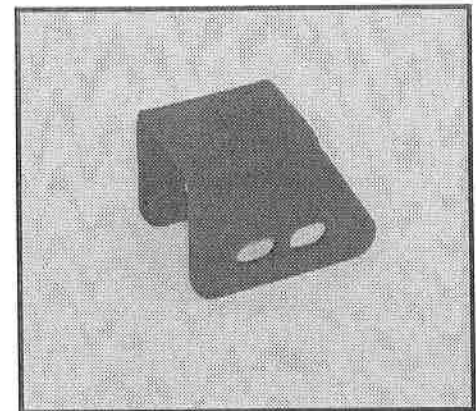

16985-11 / qty. 2

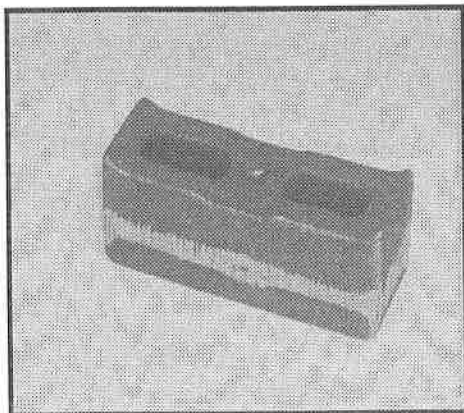

BL402 / qty. 2

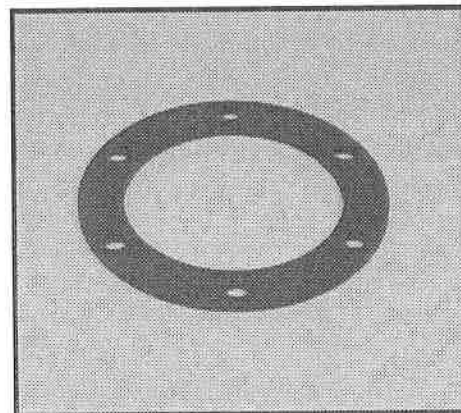

9802 / qty. 2

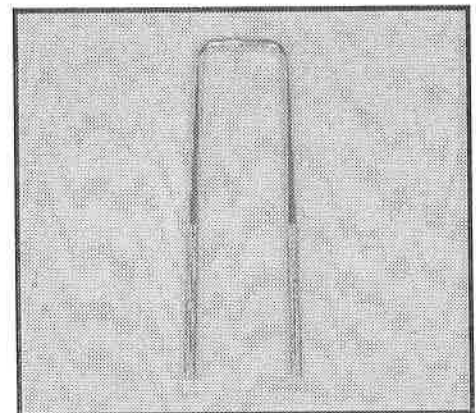

5U-9296S / qty. 4